

**OFF-
ROAD
LIVIN'**

can-am®

**OUTLANDER
RENEGADE**

PRODUCT SPEC BOOK
VEHICLE SPECIFICATIONS • ACCESSORIES

2022

**OFF-
ROAD
LIVIN'**

2022 OUTLANDER • RENEGADE

VEHICLE SPECIFICATIONS

FEATURED PACKAGES

Outlander 450/570	6
Outlander mr 570	8
Renegade	10

COMPARATIVE CHART

ATV Lineup	12
------------	----

ACCESSORIES

Compatibility Guide	24
LinQ®: Easy On, Easy Off Cargo	25
Racks & Holders	29
Cargo & Storage	31
Can-Am Windshields	32
Handlebars & Mirrors	34
Seats	35
HMWPE Skid Plates	36
Aluminum Skid Plates	37
HMWPE & Aluminum Skid Plates	39
Bumpers & Guards	40
Lights & Electrical	43
Winches	47
Hitches	49
Performance	50
Covers, Decals & Add-Ons	53
Apache Track Systems	55
Promount Plows	57
Tires & Rims	62

can-am
OUTLANDER

can-am
RENEGADE

© 2021 Bombardier Recreational Products Inc. (BRP). All rights reserved. ®, TM and the BRP logo are trademarks of BRP or its affiliates. ¹All other trademarks are the property of their respective owners. Some models depicted herein may include optional equipment. Prices, if shown, are based on Manufacturer Suggested Retail Prices. Dealers may sell for a different price. For Canada and the US, taxes are not included. Depending on location, products are distributed by BRP US Inc., Bombardier Recreational Products Inc., BRP European Distribution SA, BRP Finland Oy., BRP Australia Pty Ltd. or BRP Brasil Motorsports LTDA. BRP reserves the right, at any time, to discontinue or change specifications, prices, designs, features or equipment without incurring obligation. Printed in Canada.

CAN-AMOFFROAD.COM

A person wearing a teal jacket, a black helmet with goggles, and orange gloves is riding a blue Can-Am ATV through a forest. The ATV has large, knobby tires, a front bumper, and a winch. The headlights are on, and the Can-Am logo is visible on the front. The background consists of tall, thin trees in a wooded area.

VEHICLE SPECIFICATIONS

VEHICLE SPECIFICATIONS

FEATURED PACKAGES

Outlander 450/570	6
Outlander mr 570	8
Renegade	10

COMPARATIVE CHART

ATV Lineup	12
------------	----

**OFF-ROAD
LIVIN'**



OUTLANDER 450/570

HIGHLIGHTS

- Rotax® engine options
- Continuously Variable Transmission (CVT) with engine braking
- Double A-arm front suspension
- Torsional Trailing arm Independent (TTI) rear suspension
- Visco-Lok® auto-locking front differential
- 1,300 lb (590 kg) towing capacity
- 5.4 gal (20.5 L) fuel capacity
- 25 in. Carlisle Trail Wolf tires
- Surrounding Spar Technology (SST) G2 frame with Geometric Contact Control
- Multifunction digital gauge
- Steel racks with LinQ quick-attach accessory system and a combined 360 lb (163.3 kg) capacity
- 2.9 gal (10.9 L) water-resistant rear compartment

- Tundra Green
- Viper Red



ENGINES	450	570
Type	38 hp, Rotax 427 cc single cylinder, liquid-cooled	48 hp, Rotax 570 cc V-twin, liquid-cooled
Fuel Delivery System	Electronic Fuel Injection (EFI)	
Transmission	CVT, P/R/N/H/L, standard engine braking	
Drive Train	Selectable 2WD/4WD with Visco-Lok auto-locking front differential	
Power Steering	N/A	
SUSPENSIONS		
Front Suspension	Double A-arm 9 in. (22.9 cm) travel	
Front Shocks	Oil	
Rear Suspension	Torsional Trailing arm Independent (TTI) 8.8 in. (22.4 cm) travel	
Rear Shocks	Oil	
TIRES & WHEELS		
Front Tires	Carlisle Trail Wolf 25 x 8 x 12 in.	
Rear Tires	Carlisle Trail Wolf 25 x 10 x 12 in.	
Wheels	12 in. steel	
BRAKES		
Front	Dual 214 mm disc brakes with hydraulic twin-piston calipers	
Rear	Single 214 mm disc brake with hydraulic twin-piston caliper	

DIMENSIONS & CAPACITIES	450	570
Estimated Dry Weight*	678 lb (308 kg)	704 lb (319 kg)
L x W x H	83 x 46 x 49 in. (211 x 116.8 x 124 cm)	
Wheelbase	51 in. (129.5 cm)	
Ground Clearance	10.5 in. (26.7 cm)	
Seat Height	33.8 in. (85.8 cm)	
Rack Capacity	Front: 120 lb (54.4 kg)/Rear: 240 lb (109 kg)	
Storage Capacity	Rear: 2.9 gal (10.9 L)	
Towing Capacity	1,300 lb (590 kg)	
Fuel Capacity	5.4 gal (20.5 L)	

FEATURES

Gauge	Multifunction digital: speedometer, tachometer, odometer, trip and hour meters, fuel, gear position, 4 x 4 indicator, diagnostics, clock
Instrumentation	Lighter-type DC outlet in console, standard connector in the back (15 A)
Anti-Theft System	N/A
Lighting	70 W from dual 35 W front light/brake light
Winch	Prewired for available winch
Seat	Standard
Protection	N/A

WARRANTY & EXTENDED SERVICE

Factory Warranty	6-month BRP limited warranty
Extended Service Terms	B.E.S.T. term available up to 36 months



FEATURE HIGHLIGHTS

1

Choice of Powerful Rotax Engines

Two engines so tough that choosing won't be easy: the 38-horsepower single-cylinder Rotax 450 or 48-hp Rotax 570 V-Twin. Each offers responsive power that's strong, smooth, and efficient.

2

Tow with Confidence

The Can-Am Outlander tows 1,300 lbs (590 kg) with ease. A rear hitch plate comes standard, and the ride is pre-wired for a winch in case drivers plan to push the limits—which they will.

3

Smooth Riding

Put it in H and go: a Continuously Variable Transmission (CVT) keeps the Can-Am Outlander within its powerband, for efficient, torque-rich response at all speeds and no need to worry about selecting gears.

4

Range to Roam

Longer rides are no longer a dare. A 5.4-gallon (20.5 L) fuel capacity and Electronic Fuel Injection (EFI) means more miles per gallon and more adventures per tank.

5

Trip Info at Your Fingertips

The multifunction digital display keeps the Can-Am Outlander's crucial information at hand. Features include speedometer, gear position, temperature, engine lights control, electronic fuel gauge, clock, and more.

OUTLANDER mr 570

HIGHLIGHTS

- Rotax® V-Twin engine
- 28 in. Mega Mayhem tires
- 12 in. cast-aluminum wheels
- Visco-Lok[†] QE auto-locking front differential
- Relocated radiator
- Heavy-duty front bumper
- Mud-riding footrests
- Surrounding Spar Technology (SST) G2 frame
- Double A-arm front suspension
- Torsional Trailing arm Independent (TTI) rear suspension

 Viper Red

ENGINE	570
Type	48 hp, Rotax 570 cc V-twin, snorkeled, liquid-cooled with relocated radiator
Fuel Delivery System	Electronic Fuel Injection (EFI)
Transmission	CVT, P/R/N/H/L, standard engine braking
Drive Train	Selectable 2WD/4WD with Visco-Lok QE auto-locking front differential
Power Steering	N/A

SUSPENSIONS	
Front Suspension	Double A-arm
Front Shocks	Oil
Rear Suspension	Torsional Trailing arm Independent (TTI)
Rear Shocks	Oil

TIRES & WHEELS	
Front Tires	ITP Mega Mayhem 28 x 8 x 12 in.
Rear Tires	ITP Mega Mayhem 28 x 10 x 12 in.
Wheels	12 in. cast-aluminum

BRAKES	
Front	Dual 214 mm disc brakes with hydraulic twin-piston calipers
Rear	Single 214 mm disc brake with hydraulic twin-piston caliper

DIMENSIONS & CAPACITIES

Estimated Dry Weight*	843 lb (382 kg)
L x W x H	83 x 46 x 49 in. (211 x 116.8 x 124 cm)
Wheelbase	51 in. (129.5 cm)
Ground Clearance	11.7 in. (29.7 cm)
Seat Height	33.8 in. (85.8 cm)
Rack Capacity	Rear: 240 lb (109 kg)
Storage Capacity	Rear: 2.9 gal (10.9 L)
Towing Capacity	1,300 lb (590 kg)
Fuel Capacity	5.4 gal (20.5 L)

FEATURES

Gauge	4.5 in. digital display: speedometer, tachometer, odometer, trip and hour meters, gear position, 4 x 4 indicator, temperature, engine lights, electronic fuel gauge and clock
Instrumentation	Lighter-type DC outlet in console, standard connector in the back (15 A)
Anti-Theft System	N/A
Lighting	70 W from dual 35 W front light/brake light
Winch	Prewired for available winch
Seat	Standard
Protection	Heavy-duty front bumper Mud-riding footrests

WARRANTY & EXTENDED SERVICE

Factory Warranty	6-month BRP limited warranty
Extended Service Terms	B.E.S.T. term available up to 36 months



FEATURE HIGHLIGHTS

1

Powerful Rotax Engine

The Can-Am Outlander mr 570 leads the way with its Rotax V-Twin 48-hp engine. This ride lays down impressive torque with a responsive throttle, a signature roar, and power to spare.

2

Unlocking Limits

Thanks to Visco-Lok QE, the Can-Am Outlander mr 570 has a locked differential that unlocks possibilities. Easily operated with a faster engagement point for demanding use, this ride simply eats up mud.

3

Mud-Loving Tires

The Can-Am Outlander mr 570's 28 inch ITP Mega Mayhem tires sit on 12 inch cast-aluminum wheels. It's a combination ready to take on any challenge. Especially if that challenge involves mud.

4

Powerful Companion

The numbers are impressive: 1,300 lbs (590 kg) of towing capacity. But the Can-Am Outlander mr 570 is so much more. It's a partner for work and play, hauling loads and taking drivers along for the ride.

5

All-Terrain Protection

This ride tackles tough terrain and keeps riders safe at an equally high level. A heavy-duty front bumper and mud-riding footrests are two features allowing this rig to keep both fun and safety front and center.

RENEGADE

HIGHLIGHTS

- Rotax® V-Twin engine options
- Arched double A-arm front suspension with front sway bar
- Continuously Variable Transmission (CVT) with engine braking
- 12 in. cast-aluminum wheels
- 25 in. ITP Holeshot ATR tires
- Surrounding Spar Technology (SST) G2 frame with Geometric Contact Control
- Torsional Trailing arm Independent (TTI) rear suspension
- Visco-Lok® auto-locking front differential
- Multifunction digital gauge
- RF Digitally Encoded Security System (D.E.S.S.)

Desert Tan

ENGINES	570	850
Type	48 hp, Rotax 570 cc V-twin, liquid-cooled	78 hp, Rotax 854 cc V-twin, liquid-cooled
Fuel Delivery System	Electronic Fuel Injection (EFI)	Intelligent Throttle Control (iTC™) with Electronic Fuel Injection (EFI)
Transmission	CVT, P/R/N/H/L, standard engine braking	
Drive Train	Selectable 2WD/4WD with Visco-Lok auto-locking front differential	
Power Steering	N/A	

SUSPENSIONS

Front Suspension	Arched double A-arm with front sway bar 9.2 in. (23.3 cm) travel	
Front Shocks	Oil	FOX 1.5 PODIUM
Rear Suspension	Torsional Trailing arm Independent (TTI) 9.9 in. (25.1 cm) travel	
Rear Shocks	Oil	FOX 1.5 PODIUM

TIRES & WHEELS

Front Tires	ITP Holeshot ATR 25 x 8 x 12 in.
Rear Tires	ITP Holeshot ATR 25 x 10 x 12 in.
Wheels	12 in. cast-aluminum

BRAKES

Front	Dual 214 mm disc brakes with hydraulic twin-piston calipers
Rear	Single 214 mm disc brake with hydraulic twin-piston caliper

DIMENSIONS & CAPACITIES

	570	850
Estimated Dry Weight*	628 lb (286 kg)	681 lb (310 kg)
L x W x H	86 x 48 x 49 in. (218.4 x 121.9 x 124 cm)	
Wheelbase	51 in. (129.5 cm)	
Ground Clearance	10.5 in. (26.7 cm)	
Seat Height	34.5 in. (87.7 cm)	
Rack Capacity	Rear: 35 lb (16 kg)	
Storage Capacity	N/A	
Towing Capacity	1,300 lb (590 kg)	
Fuel Capacity	5.4 gal (20.5 L)	

FEATURES

Gauge	4.5 in. digital display: speedometer, tachometer, odometer, trip and hour meters, gear position, 4 x 4 indicator, temperature, engine lights, electronic fuel gauge and clock
Instrumentation	Lighter-type DC outlet in console, standard connector in the back (15 A)
Anti-Theft System	RF Digitally Encoded Security System (D.E.S.S.™)
Lighting	240 W from 4 fender-mounted projector beam headlamps (60 W) with tail light/brake light
Winch	Prewired for available winch
Seat	Standard
Protection	Front bumper

WARRANTY & EXTENDED SERVICE

Factory Warranty	6-month BRP limited warranty
Extended Service Terms	B.E.S.T. term available up to 36 months



FEATURE HIGHLIGHTS

1

Choice of Powerful Rotax Engines

Two engines so tough that choosing won't be easy: the 48- or 78-horsepower Rotax V-Twin. Each offers responsive power that's strong, smooth, and efficient.

2

Smooth Riding

Put it in H and go: a Continuously Variable Transmission (CVT) keeps the Can-Am Renegade within its powerband, for efficient, torque-rich response at all speeds and no need to worry about selecting gears.

3

Unlocking Limits

The Can-Am Renegade's selectable 2WD / 4WD with Visco-Lok auto-locking front differential doesn't just grip terrain. It gains maximum traction at the push of a button in all riding conditions.

4



Anti-Theft Protection



A ride this special deserves top end security. Encrypted chip technology—one vehicle, one code—restricts access to only the owner. The electronic ignition system and ball-and-socket key design team up for a reliable wireless connection.



5



Trip Info at Your Fingertips



The 4.5 inch digital display keeps the Renegade's crucial information at hand. It's backlit so that it's readable in all weather conditions.





		OUTLANDER 450/570		OUTLANDER DPS 450/570		OUTLANDER XT 570
						
COLOR OPTIONS		Tundra Green Viper Red		Granite Gray Tundra Green Mossy Oak Break-Up Country Camo		Oxford Blue Boreal Green
ENGINES	Type	450	570	450	570	570
		38 hp, Rotax 427 cc single cylinder, liquid cooled	48 hp, Rotax 570 cc V-twin, liquid cooled	38 hp, Rotax 427 cc single cylinder, liquid cooled	48 hp, Rotax 570 cc V-twin, liquid cooled	48 hp, Rotax 570 cc V-twin, liquid cooled
	Fuel Delivery System	Electronic Fuel Injection (EFI)				
	Transmission	CVT, P/R/N/H/L, standard engine braking				
	Drive Train	Selectable 2WD/4WD with Visco-Lok auto-locking front differential		Selectable 2WD/4WD with Visco-Lok QE auto-locking front differential		
Power Steering	N/A		Tri-Mode Dynamic Power Steering (DPS)			
SUSPENSIONS	Front Suspension	Double A-arm 9 in. (22.9 cm) travel				
	Front Shocks	Oil				
	Rear Suspension	Torsional Trailing arm Independent (TTI) 8.8 in. (22.4 cm) travel				
	Rear Shocks	Oil				
TIRES/WHEELS	Front Tires	Carlisle Trail Wolf 25 x 8 x 12 in.		Carlisle Trail Wolf 25 x 8 x 12 in.		
	Rear Tires Wheels	Carlisle Trail Wolf 25 x 10 x 12 in. 12-in. steel		Carlisle Trail Wolf 25 x 10 x 12 in. 12-in. cast-aluminum		
BRAKES	Front	Dual 214 mm disc brakes with hydraulic twin-piston calipers				
	Rear	Single 214 mm disc brake with hydraulic twin-piston calipers				
DIMENSIONS/CAPACITIES	Estimated Dry Weight *	678 lb (308 kg)	704 lb (319 kg)	678 lb (308 kg)	704 lb (319 kg)	704 lb (319 kg)
	L x W x H	83 x 46 x 49 in. (211 x 116.8 x 124 cm)				
	Wheelbase	51 in. (129.5 cm)				
	Ground Clearance	10.5 in. (26.7 cm)				
	Seat Height	33.8 in. (85.8 cm)				
	Rack Capacity	Front: 120 lb (54.4 kg)/Rear: 240 lb (109 kg)				
	Storage Capacity	Rear: 2.9 gal (10.9 L)				
	Fuel Capacity	5.4 gal (20.5 L)				
FEATURES	Gauge	Multifunction digital: Speedometer, tachometer, odometer, trip & hour meters, fuel, gear position, 4 x 4 indicator, diagnostics, clock		4.5-in. digital display: Speedometer, tachometer, odometer, trip & hour meters, gear position, 4 x 4 indicator, temperature, engine lights, electronic fuel gauge & clock		
	Instrumentation	Lighter type DC Outlet in console, standard connector in the back (15-A)				
	Anti-theft System	N/A				
	Lighting	70 W from dual 35-W front light/brake light				
	Winch	Prewired for available winch				3,500-lb (1,588 kg) winch
	Seat	Standard				
Protection	N/A		Heavy-duty front bumper		Heavy-duty front & rear bumpers Handlebar wind deflectors	





OUTLANDER MAX 450/570		OUTLANDER MAX DPS 450/570		OUTLANDER MAX XT 570
				
Viper Red		Granite Gray Tundra Green		Oxford Blue Boreal Green
450	570	450	570	570
38 hp, Rotax 427 cc single cylinder, liquid cooled	48 hp, Rotax 570 cc V-twin, liquid cooled	38 hp, Rotax 427 cc single cylinder, liquid cooled	48 hp, Rotax 570 cc V-twin, liquid cooled	48 hp, Rotax 570 cc V-twin, liquid cooled
Electronic Fuel Injection (EFI)				
CVT, P/R/N/H/L, standard engine braking				
Selectable 2WD/4WD with Visco-Lok auto-locking front differential		Selectable 2WD/4WD with Visco-Lok QE auto-locking front differential		
N/A		Tri-Mode Dynamic Power Steering (DPS)		
Double A-arm 9 in. (22.9 cm) travel				
Oil				
Torsional Trailing arm Independent (TTI) 8.8 in. (22.4 cm) travel				
Oil				
Carlisle Trail Wolf 25 x 8 x 12 in. Carlisle Trail Wolf 25 x 10 x 12 in. 12-in. steel		Carlisle Trail Wolf 25 x 8 x 12 in. Carlisle Trail Wolf 25 x 10 x 12 in. 12-in. cast-aluminum		
Dual 214 mm disc brakes with hydraulic twin-piston calipers				
Single 214 mm disc brake with hydraulic twin-piston calipers				
715 lb (324 kg)	741 lb (336 kg)	715 lb (324 kg)	741 lb (336 kg)	741 lb (336 kg)
91 x 46 x 52.5 in (231 x 116.8 x 133 cm)				
59 in. (149.9 cm)				
10.5 in. (26.7 cm)				
33.8 in. (85.8 cm)				
Front: 120 lb (54.4 kg)/Rear: 240 lb (109 kg)				
Rear: 2.9 gal (10.9 L)				
1,300 lb (590 kg)				
5.4 gal (20.5 L)				
Multifunction digital: Speedometer, tachometer, odometer, trip & hour meters, fuel, gear position, 4 x 4 indicator, diagnostics, clock		4.5-in. digital display: Speedometer, tachometer, odometer, trip & hour meters, gear position, 4 x 4 indicator, temperature, engine lights, electronic fuel gauge & clock		
Lighter type DC Outlet in console, standard connector in the back (15-A)				
N/A				
70 W from dual 35-W front light/brake light				
Prewired for available winch				3,500-lb (1,588 kg) winch
Convertible Rack System (CRS)				
N/A		Heavy-duty front bumper		Heavy-duty front & rear bumpers Handlebar wind deflectors

		OUTLANDER		OUTLANDER DPS	
					
COLOR OPTIONS		Viper Red		Granite Gray	
ENGINES	Type	650	850	650	850
		62 hp, Rotax 649.6 cc V-twin, liquid cooled		78 hp, Rotax 854 cc V-twin, liquid cooled	
	Fuel Delivery System	Electronic Fuel Injection (EFI)		Intelligent Throttle Control (ITC™) with Electronic Fuel Injection (EFI)	
	Transmission	CVT, P/R/N/H/L, standard engine braking			
	Drive Train	Selectable 2WD/4WD with Visco-Lok auto-locking front differential		Selectable 2WD/4WD with Visco-Lok QE auto-locking front differential	
	Power Steering	N/A		Tri-Mode Dynamic Power Steering (DPS)	
SUSPENSIONS	Front Suspension	Arched double A-arm with front sway bar 9.2 in. (23.3cm) travel			
	Front Shocks	Oil			
	Rear Suspension	Torsional Trailing arm Independent (TTI) 9.9 in. (25.1 cm) travel			
	Rear Shocks	Oil			
TIRES/WHEELS	Front Tires	Carlisle ¹ ACT radial 26 x 8 x 12 in.		ITP ¹ Terracross 26 x 8 x 14 in.	
	Rear Tires Wheels	Carlisle ACT radial 26 x 10 x 12 in. 12-in. steel		ITP ¹ Terracross 26 x 10 x 14 in. 14-in. cast-aluminum	
BRAKES	Front	Dual 214 mm disc brakes with hydraulic twin-piston calipers			
	Rear	Single 214 mm disc brake with hydraulic twin-piston calipers			
DIMENSIONS/CAPACITIES	Estimated Dry Weight *	749 lb (341kg)	800 lb (363 kg)	749 lb (341kg)	800 lb (363 kg)
	L x W x H	86 x 48 x 49.5 in. (218.4 x 121.9 x 126 cm)			
	Wheelbase	51 in. (129.5 cm)			
	Ground Clearance	11 in. (27.9 cm)			
	Seat Height	34.5 in. (87.7 cm)			
	Rack Capacity	Front: 100 lb (45 kg)/Rear: 200 lb (90 kg)			
	Storage Capacity	Rear: 5.7 gal (21.4 L)			
	Towing Capacity	1,650 lb (750 kg)			
	Fuel Capacity	5.4 gal (20.5 L)			
FEATURES	Gauge	4.5-in. digital display: Speedometer, tachometer, odometer, trip & hour meters, gear position, 4 x 4 indicator, temperature, engine lights, electronic fuel gauge & clock			
	Instrumentation	Lighter type DC Outlet in console, standard connector in the back (15-A)			
	Anti-theft System	N/A	RF Digitally Encoded Security System (D.E.S.S.)	N/A	RF Digitally Encoded Security System (D.E.S.S.)
	Lighting	230 W from twin 60-W projectors and dual 55-W reflectors with tail light/brake light			
	Winch	Prewired for available winch			
	Seat	Standard			
	Protection	Mudguards		Mudguards	





OUTLANDER XT			OUTLANDER XT-P		OUTLANDER X xc
					
Oxford Blue Boreal Green Mossy Oak Break-Up Country Camo			Iron Gray, Black & Neo Yellow		Chalk Gray & Magma Red
650	850	1000R	850	1000R	1000R
62 hp, Rotax 650 cc V-twin, liquid cooled	78 hp, Rotax 854 cc V-twin, liquid cooled	91 hp, Rotax 976 cc V-twin, liquid cooled	78 hp, Rotax 854 cc V-twin, liquid cooled	91 hp, Rotax 976 cc V-twin, liquid cooled	91 hp, Rotax 976 cc V-twin, liquid cooled
Electronic Fuel Injection (EFI)	Intelligent Throttle Control (ITC™) with Electronic Fuel Injection (EFI)				
CVT, P/R/N/H/L, standard engine braking					
Selectable 2WD/4WD with Visco-Lok QE auto-locking front differential			Selectable 2WD/4WD/Lock 4WD with Visco-4Lok front differential		Selectable 2WD/4WD with Visco-Lok QE auto-locking front differential
Tri-Mode Dynamic Power Steering (DPS)					
Arched double A-arm with front sway bar 9.2 in. (23.3cm) travel					
Oil			FOX® 1.5 PODIUM® QS3		FOX® 1.5 PODIUM® RC2
Torsional Trailing arm Independent (TTI) 9.9 in. (25.1 cm) travel					
Oil			FOX® 1.5 PODIUM® QS3		FOX® 1.5 PODIUM® RC2
ITP® Terracross 26 x 8 x 14 in. ITP® Terracross 26 x 10 x 14 in. 14-in. cast-aluminum			ITP® Terracross 26 x 8 x 14 in. ITP® Terracross 26 x 10 x 14 in. 14-in. cast-aluminum beadlock		ITP® Terracross 26 x 8 x 14 in. ITP® Terracross 26 x 10 x 14 in. 14-in. cast-aluminum beadlock
Dual 214 mm disc brakes with hydraulic twin-piston calipers					
Single 214 mm disc brake with hydraulic twin-piston calipers					
749 lb (341 kg)	800 lb (363 kg)	826 lb (375 kg)	800 lb (363 kg)	826 lb (375 kg)	826 lb (375 kg)
86 x 48 x 49.5 in. (218.4 x 121.9 x 126 cm)					
51 in. (129.5 cm)					
11 in. (27.9 cm)					
34.5 in. (87.7 cm)					
Front: 100 lb (45 kg)/Rear: 200 lb (90 kg)					Rear: 200 lb (90 kg)
Rear: 5.7 gal (21.4 L)					
1,650 lb (750 kg)					
5.4 gal (20.5 L)					
4.5-in. digital display: Speedometer, tachometer, odometer, trip & hour meters, gear position, 4 x 4 indicator, temperature, engine lights, electronic fuel gauge & clock			7.6-in wide digital display: Speedometer, tachometer, odometer, trips & hour meters, gear position, 4 x 4 indicator, temperature, engine lights, electronic fuel gauge, clock		
Lighter type DC Outlet in console, standard connector in the back (15-A)					
N/A	RF Digitally Encoded Security System (D.E.S.S.)				
230 W from twin 60-W projectors and dual 55-W reflectors with tail light/brake light					
3,500-lb (1,588 kg) winch					Prewired for available winch
Standard					
Heavy-duty front & rear bumpers Handlebar wind deflectors Mudguards			Heavy-duty front & rear bumpers Aluminum taper-profile handlebar with full wrap handguards Mudguards		Aluminum front bumper with pre-runner and top brace Aluminum taper-profile handlebar with full wrap handguards Front, center & footwell aluminum skid plates A-arms HMWPE protectors Mudguards

		OUTLANDER MOSSY OAK EDITION			OUTLANDER MAX DPS		OUTLANDER MAX XT		
									
COLOR OPTIONS		Mossy Oak Break-Up Country Camo			Granite Gray		Oxford Blue Boreal Green Mossy Oak Break-Up Country Camo		
ENGINES	Type	450	570	650	650	650	850	1000R	
		38 hp, Rotax 427 cc single cylinder, liquid cooled	48 hp, Rotax 570 cc V-twin, liquid cooled	62 hp, Rotax 650 cc V-twin, liquid cooled	62 hp, Rotax 650 cc V-twin, liquid cooled	62 hp, Rotax 650 cc V-twin, liquid cooled	78 hp, Rotax 854 cc V-twin, liquid cooled	91 hp, Rotax 976 cc V-twin, liquid cooled	
	Fuel Delivery System	Electronic Fuel Injection (EFI)						Intelligent Throttle Control (ITC™) with Electronic Fuel Injection (EFI)	
	Transmission	CVT, P/R/N/H/L, standard engine braking							
	Drive Train	Selectable 2WD/4WD with Visco-Lok QE auto-locking front differential							
	Power Steering	Tri-Mode Dynamic Power Steering (DPS)							
SUSPENSIONS	Front Suspension	Double A-arm 9 in. (22.9 cm) travel			Arched double A-arm with front sway bar 9.2 in. (23.3cm) travel				
	Front Shocks	Oil							
	Rear Suspension	Torsional Trailing arm Independent (TTI) 8.8 in. (22.4 cm) travel			Torsional Trailing arm Independent (TTI) 9.9 in. (25.1 cm) travel				
	Rear Shocks	Oil							
TIRES/WHEELS	Front Tires	Carlisle ACT HD 26 x 8 x 12 in.			ITP ¹ Terracross 26 x 8 x 14 in.				
	Rear Tires	Carlisle ACT HD 26 x 10 x 12 in.			ITP ¹ Terracross 26 x 10 x 14 in.				
BRAKES	Front	Dual 214 mm disc brakes with hydraulic twin-piston calipers							
	Rear	Single 214 mm disc brake with hydraulic twin-piston calipers							
DIMENSIONS/CAPACITIES	Estimated Dry Weight *	678 lb (308 kg)	704 lb (319 kg)	749 (341 kg)	827 lb (375 kg)	827 lb (375 kg)	874 lb (396 kg)	900 lb (408 kg)	
	L x W x H	83 x 46 x 49 in. (211 x 116.8 x 124 cm)			86 x 48 x 49.5 in. (218.4 x 121.9 x 126 cm)	94 x 48 x 53 in. (238.8 x 121.9 x 135 cm)			
	Wheelbase	51 in. (129.5 cm)				59 in. (149.9 cm)			
	Ground Clearance	11.5 in. (29.2 cm)			12 in. (30.5 cm)	11 in. (27.9 cm)			
	Seat Height	33.8 in. (85.8 cm)				34.5 in. (87.7 cm)			
	Rack Capacity	Front: 120 lb (54.4 kg)/ Rear: 240 lb (109 kg)				Front: 100 lb (45 kg)/Rear: 200 lb (90 kg)			
	Storage Capacity	Rear: 2.9 gal (10.9 L)				Rear: 5.7 gal (21.4 L)			
	Towing Capacity	1,300 lb (590 kg)				1,650 lb (750 kg)			
	Fuel Capacity	5.4 gal (20.5 L)							
FEATURES	Gauge	4.5-in. digital display: Speedometer, tachometer, odometer, trip & hour meters, gear position, 4 x 4 indicator, temperature, engine lights, electronic fuel gauge & clock							
	Instrumentation	Lighter type DC Outlet in console, standard connector in the back (15-A)							
	Anti-theft System	N/A					RF Digitally Encoded Security System		
	Lighting	70 W from dual 35-W front light/brake light			230 W from twin 60-W projectors and dual 55-W reflectors with tail light/brake light				
	Winch	3,500-lb (1,588 kg) winch				Prewired for available winch	3,500-lb (1,588 kg) winch		
	Seat	Reinforced seat skin				Convertible Rack System (CRS)			
	Protection	Heavy-duty front & rear bumpers Front, central & footwell aluminum skid plates Aluminum a-arms protectors Heated grips & throttle Handlebar wind deflectors			Heavy-duty front & rear bumpers Front, central & footwell aluminum skid plates A-arms & TTI HMWPE protectors Heated grips & throttle Handlebar wind deflectors Mudguards	Mudguards	Heavy-duty front & rear bumpers Handlebar wind deflectors Mudguards		

OUTLANDER MAX XT-P		OUTLANDER MAX LIMITED		OUTLANDER mr 570	OUTLANDER X mr 570	OUTLANDER X mr 650
						
Iron gray, Black & Neo Yellow		Stone Gray		Viper Red	Desert Tan	Desert Tan
850		1000R		1000R	570	650
78 hp, Rotax 854 cc V-twin, liquid cooled		91 hp, Rotax 976 cc V-twin, liquid cooled		91 hp, Rotax 976 cc V-twin, liquid cooled	48 hp, Rotax 570 cc V-twin, snorkeled, liquid cooled with relocated radiator	48 hp, Detuned Rotax 650 cc V-twin, snorkeled, liquid cooled with relocated radiator
Intelligent Throttle Control (ITC™) with Electronic Fuel Injection (EFI)				Electronic Fuel Injection (EFI)	Intelligent Throttle Control (ITC™) with Electronic Fuel Injection (EFI)	
CVT, P/R/N/H/L, standard engine braking						
Selectable 2WD/4WD/Lock 4WD with Visco-4Lok front differential				Selectable 2WD/4WD with Visco-Lok QE auto-locking front differential	Selectable 2WD/4WD/Lock 4WD with Visco-4Lok front differential	
Tri-Mode Dynamic Power Steering (DPS)				N/A	Tri-Mode Dynamic Power Steering (DPS)	
Arched double A-arm with front sway bar 9.2 in. (23.3 cm) travel				Double A-arm	Arched double A-arm with front sway bar	
FOX® 1.5 PODIUM® QS3				Oil		
Torsional Trailing arm Independent (TTI) 9.9 in. (25.1 cm) travel				Torsional Trailing arm Independent (TTI)		
FOX® 1.5 PODIUM® QS3				Oil		
ITP® Terracross 26 x 8 x 14 in. ITP® Terracross 26 x 10 x 14 in. 14-in. cast-aluminum beadlock		Maxxis Bighorn 2.0 27 x 9 x 14 in. Maxxis Bighorn 2.0 27 x 11 x 14 in. 14-in. cast-aluminum		ITP® Mega Mayhem 28 x 8 x 12 in. ITP® Mega Mayhem 28 x 10 x 12 in. 12-in. cast-aluminum		
Dual 214 mm disc brakes with hydraulic twin-piston calipers						
Single 214 mm disc brake with hydraulic twin-piston calipers						
874 lb (396 kg)		900 lb (408 kg)		843 lb (382 kg)		874 lb (396 kg)
94 x 48 x 53 in. (238.8 x 121.9 x 135 cm)				83 x 46 x 49 in. (211 x 116.8 x 124 cm)		88 x 48.5 x 50.5 in. (224 x 123 x 128 cm)
59 in. (149.9 cm)				51 in. (129.5 cm)		
11 in. (27.9 cm)				11.7 in. (29.7 cm)		11.75 in. (29.9 cm)
34.5 in. (87.7 cm)				33.8 in. (85.8 cm)		35.25 in. (89.5 cm)
Front: 100 lb (45 kg)/Rear: 200 lb (90 kg)				Rear: 240 lb (109 kg)		Rear: 200 lb (90 kg)
Rear: 5.7 gal (21.4 L)				Rear: 2.9 gal (10.9 L)		Rear: 5.7 gal (21.4 L)
1,650 lb (750 kg)				1,300 lb (590 kg)		1,650 lb (750 kg)
5.4 gal (20.5 L)						
7.6-in wide digital display: Speedometer, tachometer, odometer, trips & hour meters, gear position, 4 x 4 indicator, temperature, engine lights, electronic fuel gauge, clock				4.5-in. digital display: Speedometer, tachometer, odometer, trip & hour meters, gear position, 4 x 4 indicator, temperature, engine lights, electronic fuel gauge & clock		
Lighter type DC Outlet in console, standard connector in the back (15-A)						
RF Digitally Encoded Security System				N/A	RF Digitally Encoded Security System	
230 W from twin 60-W projectors and dual 55-W reflectors with tail light/brake light				70 W from dual 35-W front light/brake light		230 W from twin 60-W projectors and dual 55-W reflectors with tail light/brake light
3,500-lb (1,588 kg) winch				Prewired for available winch		
Convertible Rack System (CRS)				Standard		
Heavy-duty front & rear bumpers Aluminum taper-profile handlebar with full wrap handguards Mudguards		Heavy-duty front & rear bumpers Handlebar wind deflectors Mudguards		Heavy-duty front bumper Mud-riding footrests		Heavy-duty front bumper Mud-riding footrests Mudguards

		OUTLANDER X mr 850	OUTLANDER X mr 1000R	OUTLANDER MAX 6x6 DPS 450	OUTLANDER MAX 6x6 DPS 650	OUTLANDER MAX 6x6 XT 1000
						
COLOR OPTIONS		Desert Tan	Liquid Titanium & Magma Red Desert Tan	Tundra Green	Tundra Green	Boreal Green
ENGINES	Type	850	1000R	450	650	1000
		78 hp, Rotax 854 cc V-twin, snorkeled, liquid cooled with relocated radiator	91 hp, Rotax 976 cc V-twin, snorkeled, liquid cooled with relocated radiator	38 hp, Rotax 427 cc single cylinder, liquid cooled	62 hp, Rotax 650 cc V-twin, liquid cooled	82 hp, Rotax 976 cc V-twin, liquid cooled
	Fuel Delivery System	Intelligent Throttle Control (ITC™) with Electronic Fuel Injection (EFI)			Electronic Fuel Injection (EFI)	
	Transmission	CVT, P/R/N/H/L, standard engine braking	CVT, P/R/N/H/Extra Low L, standard engine braking			
	Drive Train	Selectable 2WD/4WD/Lock 4WD with Visco-4Lok front differential			Selectable 4WD/6WD with Visco-Lok QE auto-locking front differential	
	Power Steering	Tri-Mode Dynamic Power Steering (DPS)				
SUSPENSIONS	Front Suspension	Arched double A-arm with front sway bar		Double A-arm 9 in. (22.9 cm) travel	Arched double A-arm with front sway bar 9.2 in. (23.3cm) travel	
	Front Shocks	FOX® 1.5 PODIUM®		Oil		
	Rear Suspension	Torsional Trailing arm Independent (TTI)		Double Torsional Trailing arm Independent (TTI2) with quick-release sway bar 8.8 in. (22.4 cm) travel	Double Torsional Trailing arm Independent (TTI2) with quick-release sway bar 9.9 in. (25.1 cm) travel	
	Rear Shocks	FOX® 1.5 PODIUM®		Oil		
TIRES/ WHEELS	Front Tires	ITP Cryptid 30 x 9 x 14 in.		Carlisle ACT radial 26 x 8 x 12 in.		
	Rear Tires Wheels	ITP Cryptid 30 x 9 x 14 in. 14-in. cast-aluminum		Carlisle ACT radial 26 x 10 x 12 in. 12-in. cast-aluminum		
BRAKES	Front	Dual 214 mm disc brakes with hydraulic twin-piston calipers				
	Rear	Single 214 mm disc brake with hydraulic twin-piston calipers				
DIMENSIONS/CAPACITIES	Estimated Dry Weight *	990 lb (450 kg)	1,014 lb (460 kg)	1,000 lb (454 kg)	1,100 lb (499 kg)	1,170 lb (531 kg)
	L x W x H	88 x 50 x 51.5 in. (224 x 127 x 131 cm)	97 x 50 x 51.5 in. (246 x 127 x 131 cm)	118 x 46 x 57 in (300 x 117 x 145 cm)	124.8 x 48.5 x 55.3 in. (317 x 123 x 140 cm)	
	Wheelbase	51 in. (129.5 cm)	59 in. (149.9 cm)		90 in. (228.5cm)	
	Ground Clearance	13 in. (33 cm)		10.5 in. (26.7 cm)	11 in. (27.9 cm)	
	Seat Height	36.75 in. (93.3 cm)		33.8 in. (85.8 cm)	34.5 in. (87.7 cm)	
	Rack Capacity	Rear: 200 lb (90 kg)		Front: 120 lb (54.4 kg)/ Rear: 350 lb (159 kg)	Front: 100 lb (45 kg)/Rear: 700 lb (318 kg)	
	Storage Capacity	Rear: 5.7 gal (21.4 L)		Rear: 2.9 gal (10.9 L)	Dual-level cargo box with sidewalls and tailgate Rear: 18.5 gal (70 L)	
	Towing Capacity	1,650 lb (750 kg)				
Fuel Capacity	5.4 gal (20.5 L)					
FEATURES	Gauge	7.6-in wide digital display: Speedometer, tachometer, odometer, trips & hour meters, gear position, 4 x 4 indicator, temperature, engine lights, electronic fuel gauge, clock		4.5-in. digital display: Speedometer, tachometer, odometer, trip & hour meters, gear position, 4 x 4 indicator, temperature, engine lights, electronic fuel gauge & clock		
	Instrumentation	Lighter type DC Outlet in console, standard connector in the back (15-A)				
	Anti-theft System	RF Digitally Encoded Security System			N/A	
	Lighting	230 W from twin 60-W projectors and dual 55-W reflectors with tail light/brake light				
	Winch	3,500-lb (1,588 kg) winch		Prewired for available winch		3,500-lb (1,588 kg) winch
	Seat	Standard		Convertible Rack System (CRS)		
Protection	Heavy-duty front & rear bumpers Mud-riding footrests Mudguards		Central skid plate		Heavy-duty front bumper Handlebar wind deflectors Central skid plate	

RENEGADE		RENEGADE X xc		RENEGADE X mr 650	RENEGADE X mr 1000R
					
Desert Tan		Desert Tan & Carbon Black Chalk Gray & Magma Red		Desert Tan & Carbon Black	Liquid Titanium & Magma Red Desert Tan & Carbon Black
570	850	850	1000R	650	1000R
48 hp, Rotax 570 cc V-twin, liquid cooled	78 hp, Rotax 854 cc V-twin, liquid cooled	78 hp, Rotax 854 cc V-twin, liquid cooled	91 hp, Rotax 976 cc V-twin, liquid cooled	62 hp, Rotax 650 cc V-twin, snorkeled, liquid cooled	91 hp, Rotax 976 cc V-twin, snorkeled, liquid cooled
Electronic Fuel Injection (EFI)	Intelligent Throttle Control (ITC™) with Electronic Fuel Injection (EFI)				
CVT, P/R/N/H/L, standard engine braking					CVT, P / R / N / H / Extra Low L, standard engine braking
Selectable 2WD/4WD with Visco-Lok auto-locking front differential		Selectable 2WD/4WD with Visco-Lok QE auto-locking front differential		Selectable 2WD/4WD/Lock 4WD with Visco-4Lok front differential	
N/A		Tri-Mode Dynamic Power Steering (DPS)			
Arched double A-arm with front sway bar 9.2 in. (23.3 cm) travel				Arched double A-arm with front sway bar	
Oil	FOX® 1.5 PODIUM®	FOX® 1.5 PODIUM® RC2		FOX® 1.5 PODIUM®	FOX® 1.5 PODIUM® QS3
Torsional Trailing arm Independent (TTI) 9.9 in. (25.1 cm) travel				Torsional Trailing arm Independent (TTI)	
Oil	FOX® 1.5 PODIUM®	FOX® 1.5 PODIUM® RC2		FOX® 1.5 PODIUM®	FOX® 1.5 PODIUM® QS3
ITP Holeshot® ATR 25 x 8 x 12 in. ITP Holeshot® ATR 25 x 10 x 12 in. 12-in. cast-aluminum		ITP Holeshot® ATR 25 x 8 x 12 in. ITP Holeshot® ATR 25 x 10 x 12 in. 12-in. cast-aluminum beadlock		ITP Mega Mayhem 28 x 8 x 12 in. ITP Mega Mayhem 28 x 10 x 12 in. 12-in. cast-aluminum beadlock	ITP Cryptid 30 x 9 x 14 in. ITP Cryptid 30 x 9 x 14 in. 14-in. cast-aluminum beadlock
Dual 214 mm disc brakes with hydraulic twin-piston calipers					
Single 214 mm disc brake with hydraulic twin-piston caliper					
628 lb (286 kg)	681 lb (310 kg)	686 lb (312 kg)	710 lb (323 kg)	865 lb (393 kg)	991 lb (450 kg)
86 x 48 x 49 in. (218.4 x 121.9 x 124 cm)				83 x 50 x 56 in. (224 x 127 x 131 cm)	
51 in. (129.5 cm)					
10.5 in. (26.7 cm)				12 in. (30.5 cm)	12.5 in. (31.8 cm)
34.5 in. (87.7 cm)				35.25 in. (89.5 cm)	36.75 in. (93.3 cm)
Rear: 35 lb (16 kg)					
N/A					
1,300 lb (590 kg)					
5.4 gal (20.5 L)					
4.5-in. digital display: Speedometer, tachometer, odometer, trip & hour meters, gear position, 4 x 4 indicator, temperature, engine lights, electronic fuel gauge & clock					
Lighter type DC Outlet in console, standard connector in the back (15-A)					
RF Digitally Encoded Security System					
240 W from 4 fender mounted projector beam headlamps (60-W) with tail light/brake light					
Prewired for available winch					3,500-lb (1,588 kg) winch
Standard					
Front bumper	Front bumper Aluminum taper-profile handlebar with full wrap handguards Front & central skid plate			Front & rear bumpers Aluminum taper-profile handlebar with grab handle and full wrap handguards Mudguards Front & central aluminum skid plate	

		DS 70	DS 90	DS 90 X	DS 250	
						
COLOR OPTIONS		Can-Am Red White	Can-Am Red White	Black & Can-Am Red	Black & Can-Am Red	
ENGINES		70	90	90	250	
	Type	4-stroke single cylinder, air cooled		89.5 cc 4-stroke single cylinder, air cooled	89.5 cc 4-stroke single cylinder, air cooled	249.4 cc 4-stroke single cylinder, liquid cooled
	Fuel Delivery System	Carburetion				
	Transmission	CVT, F/N/R				
	Drive Train	Chain driven/solid axle Electric and kick starting system			Chain driven/solid axle	
	Power Steering	N/A				
SUSPENSIONS	Front Suspension	Independent A-arm 3.4 in. (8.6 cm) travel		Double A-arm 7 in. (17.6 cm) travel	Double A-arm 5.5 in. (14 cm) travel	
	Front Shocks	Oil		HPG Piggyback	Oil	
	Rear Suspension	Swingarm 6.3 in. (16 cm) travel		Swingarm 9 in. (22.9 cm) travel	Swingarm 6.7 in. (17 cm) travel	
	Rear Shocks	Oil		HPG Piggyback	Oil	
TIRES/ WHEELS	Front Tires	Duro Thrasher 19 x 7 x 8 in.		Kenda Claw 20 x 6 x 10 in.	Kenda 22 x 7 x 10 in.	
	Rear Tires	Duro Power Trail 18 x 9.5 x 8 in.		Kenda Claw 18 x 10.5 x 8 in.	Kenda 20 x 11 x 9 in.	
	Wheels	8-in. steel		8-in. aluminum	Front: 10-in. silver steel/ Rear: 9-in. silver steel	
BRAKES	Front	Dual drum brakes		Dual hydraulic disc brakes		
	Rear	Single drum brakes		Single hydraulic disc brakes		
DIMENSIONS/CAPACITIES	Estimated Dry Weight *	250 lb (113 kg)			429 lb (195 kg)	
	L x W x H	59.8 x 35.6 x 36.8 in. (152 x 90.5 x 93.5 cm)		59.8 x 43.7 x 38.2 in. (152 x 111 x 97 cm)	72 x 40.5 x 43.5 in. (183 x 103 x 110.5 cm)	
	Wheelbase	39 in. (100 cm)			47 in. (118.7 cm)	
	Ground Clearance	8.3 in. (21.1 cm) under frame/4.5 in. (11.4 cm) under rear axle			10.2 in. (26 cm) center of ATV	
	Seat Height	27 in. (68.5 cm)			31.5 in. (80 cm)	
	Rack Capacity	N/A				
	Storage Capacity	Front: 0.7 gal. (2.7 L)			N/A	
	Towing Capacity	N/A				
	Fuel Capacity	1.6 gal (6 L)			3.3 gal (12.5 L)	
FEATURES	Gauge	Neutral and reverse lights			Neutral light, reverse light and oil/temperature light	
	Instrumentation	N/A				
	Anti-theft System	N/A				
	Lighting	Day lights		N/A	2 headlamps (35 W) with tail light and brake light	
	Winch	N/A				
	Seat	Standard				
	Protection	N/A		Aluminum front bumper with number plate Handlebar riser block (+ 1 in.) with square race-style handlebar pad Nerf bars Racing kick-up pegs	N/A	



ACCESSORIES

ACCESSORIES



ACCESSORIES

Compatibility Guide	24	Bumpers & Guards	40
LinQ®: Easy On, Easy Off Cargo	25	Lights & Electrical	43
Racks & Holders	29	Winches	47
Cargo & Storage	31	Hitches	49
Can-Am Windshields	32	Performance	50
Handlebars & Mirrors	34	Covers, Decals & Add-Ons	53
Seats	35	Apache Track Systems	55
HMWPE Skid Plates	36	Promount Plows	57
Aluminum Skid Plates	37	Tires & Rims	62
HMWPE & Aluminum Skid Plates	39		

IT'S ALL HERE, NOW GET OUT THERE.



FIT AND COMPATIBILITY

For us, innovation is a no-brainer. All our accessories work together, right out of the box. So take your pick. Then pick some more.



STYLE AND VISION

We've upped the ante when it comes to accessories. Not just designed to look good, but perform right for real riders. All killer, no filler.



QUALITY AND RELIABILITY

Our Can-Am accessories are made right the first time. And to top it off we threw in a 1-year warranty. You're welcome. Install them yourself or at an authorized dealer.

BRP 1-YEAR LIMITED WARRANTY*

For new Can-Am accessories, genuine parts, and co-branded products sold through BRP. Includes items installed by you or an authorized BRP dealer.

can-am

*Use other than which the product is designed for will void the product limited warranty. Other exclusions may apply, the warranty is subject to the exclusions, limitations of liabilities and all other terms and conditions of BRP's standard limited warranty. See complete limited warranty or contact your Can-Am Off-Road authorized dealer. Applies only to BRP-made products or co-branded products made by currently accredited BRP partners. Purchased at an authorized BRP dealership/distributor or from a BRP-authorized online store. Unless otherwise stipulated or required by law. This limited warranty does not apply to factory installed accessories. This limited warranty does not apply on Evinrude parts and accessories. This limited warranty is effective as of March 1, 2016.

ATV ACCESSORY COMPATIBILITY GUIDE

We've made things super simple.

- Check your model year
- Choose engine and model
- Learn your **PLATFORM CODE**

This **PLATFORM CODE** will let you know at a glance if the accessory is compatible with your vehicle.

MODEL YEAR	MODEL	ENGINE CONFIGURATION	PLATFORM CODE
2015	Outlander L	450, 500	G2L
	Outlander	500, 650, 800, 1000	G2
	Outlander L MAX	450, 500	G2L
	Outlander MAX	500, 650, 800, 1000	G2
	6x6	650, 1000	G2
	Renegade	500, 800, 1000	G2S
2016	Outlander L	450, 570	G2L
	Outlander	570, 650, 850, 1000	G2
	Outlander L MAX	450, 570	G2L
	Outlander MAX	570, 650, 850, 1000	G2
	6x6	650, 1000	G2
	Renegade	570, 850, 1000	G2S
2017 2018	Outlander	450, 570	G2L
	Outlander	650, 850, 1000	G2
	Outlander MAX	450, 570	G2L
	Outlander MAX	650, 850, 1000	G2
	6x6	650, 1000	G2
	Renegade	570, 850, 1000	G2S
2019 2020 2021 2022	Outlander	450, 570	G2L
	Outlander	650, 850, 1000R	G2
	Outlander MAX	450, 570	G2L
	Outlander MAX	650, 850, 1000R	G2
	6x6	450	G2L
	6x6	650, 1000	G2
	Renegade	570, 650, 850, 1000R	G2S



LinQ®: EASY ON, EASY OFF CARGO

LinQ ACCESSORIES

- No tools needed: Quickly install and remove accessories by hand.
- Equip your Can-Am for specialized tasks in no time.
- Sturdy mounting system that holds up to the roughest terrain.

	COMPATIBILITY/REQUIREMENTS		
	OUTLANDER 450/570	OUTLANDER	RENEGADE
LinQ ACCESSORIES WITH 16" BASE	<ul style="list-style-type: none"> • LinQ anchors mounted 16 inches apart, center-to-center. • Lower loading capacity than the LinQ with 36" base accessories. • Can be used on Can-Am ATV and SSV vehicles, Can-Am Spyder and Ryker vehicles, Sea-Doo watercraft and Ski-Doo snowmobiles. 		
LinQ 4.2 Gal (16 L) Cooler 295100698	LinQ Adapter Plate 715007273 & LinQ Base Installation Kit 715008125	LinQ Anchor Adapter Kit 715004960	LinQ Luggage Rack 715001734 OR LinQ Adaptor Plate 715007274 & LinQ Base Installation Kit 715008125
LinQ Tool Box 715008111			
LinQ SR 5.5 Gal (21 L) Bag 860202449			
LinQ 4.5 Gal (17 L) Sport Bag 860202447			
LinQ Modular Box 715005494 • (10 L) 715007112 • (20 L) 715006830 • (30 L)			
LinQ Tool Kit 715006829			
LinQ Dry Bag 715008110			
LinQ ACCESSORIES WITH 36" BASE	<ul style="list-style-type: none"> • Mount on LinQ racks often used by Can-Am ORV vehicles. • Higher loading capacity than the LinQ with 16" base accessories. • Usage is limited to Can-Am ORV vehicles. 		
LinQ 12 Gal (45 L) Cargo Box 715003879	LinQ Base 715002350	No further requirements	LinQ Luggage Rack 715001734
LinQ 23 Gal (86 L) Trunk Box 715004923	No compatibility		
LinQ 32 Gal (121 L) Trunk Box 715001747 (2-up) / 715001749 (MAX)	No compatibility		
LinQ 11.5 Gal (43 L) Audio Cargo Box 715003018	LinQ Base 715002350		
LinQ 8 Gal (30 L) Cooler Box 715004778 • Black / 715004698 • Grey	No compatibility		
LinQ Premium Storage Bag by OGIO 715002923 • Black / 715003248 • Camo	LinQ Base 715002350		
LinQ Heavy Duty Basket 715001215	LinQ Base 715002350		
LinQ Low Profile Basket 715004282			
LinQ HOLDERS			
LinQ 4" Rack 715001711 • Silver / 715001665 • Black	Not compatible *Alternative 5" or 8" Rack Extensions (715001913 or 715001914) are available for G2L	No further requirements	LinQ Luggage Rack 715001734
LinQ 6" (15 cm) Rack Extension 715001712 • Silver / 715001671 • Black			
LinQ Mounted Gear Grips 715005340	LinQ Base 715002350		
LinQ Tool Holder 715007358	LinQ Base 715002350		
LinQ Gun Boot Rack 715002112 715002113	Not compatible *Alternative Gun Boot Racks (715001918 or 715001919) are available for G2L		No compatibility

LinQ ACCESSORIES WITH 16" BASE

LinQ Modular Box	G2, G2L, G2S	715005494 • (10 L)	595 zł
		715007112 • (20 L)	694 zł
		715006830 • (30 L)	792 zł
	<ul style="list-style-type: none"> Allows stacking of other modular boxes to always have the right gear accessible. Always have the right box size to fit everything. 	<ul style="list-style-type: none"> Can be installed on any LinQ base with a 16" width. See table for installation location and requirements. 	
Thermal Insert For LinQ Modular Box (10 L)	G2, G2L, G2S	219401110	254 zł
	<ul style="list-style-type: none"> Insulated liner. Fits very well in the LinQ Modular Box (10 L). Can contain five 473 ml cans or six 355 ml cans. 		
LinQ Tool Kit	G2, G2L, G2S	715006829	1 364 zł
	<ul style="list-style-type: none"> Includes: <ul style="list-style-type: none"> Cutter pliers. Long-nose pliers. Locking pliers. Ratchet wrench 3/8" drive. 6" ratchet extension. Integrated CVT belt storage location (belt not included). Long-socket 19 mm 3/8" drive - 6pts. Socket 18 mm 3/8" drive. Long-socket 17 mm 3/8" drive - 6pts. Socket 15 mm 3/8" drive. Socket 13 mm 3/8" drive. Socket 10 mm 3/8" drive. Socket 8 mm 3/8" drive. Combined wrench 19 mm. Combined wrench 18 mm. Combined wrench 15 mm. Combined wrench 13 mm. Combined wrench 10 mm. Combined wrench 8 mm. Socket torx T30 3/8" drive. Socket torx T20 3/8" drive. Breaker bar 3/8" drive. See table for installation location and requirements. 		
LinQ 4.2 Gal (16 L) Cooler	G2, G2L, G2S	<ul style="list-style-type: none"> 219400964 • Black 295100698 • Grey 	<ul style="list-style-type: none"> 1 538 zł 1 602 zł
	<ul style="list-style-type: none"> All the benefits of LinQ—simple, fast and secure. Rotomolded construction for exceptional rigidity and durability. Premium-quality foam insulation for optimal ice retention. 	<ul style="list-style-type: none"> Uses LinQ mounting system (Patent US 8777531 and US 8875830). Easy one-second on/off tool-less system. See table for installation location and requirements. 	
LinQ Tool Box	G2, G2L, G2S	715008111	- zł
	<ul style="list-style-type: none"> High precision injected HDPE construction provides rigidity and durability. 5 gal (19 L) maximum capacity. Weather-resistant, sealed and lockable cover. Marinized for salt water purposes. See table for installation location and requirements. 		
LinQ Dry Bag	G2, G2L, G2S	715008110	995 zł
	<ul style="list-style-type: none"> Fully waterproof roll-top dry bag will securely store and confine your equipment. LinQ mounted using heavy-duty rigid plastic base. High capacity storage solution 10.6 gal (40 L). 	<ul style="list-style-type: none"> Bottom foam liner for additional equipment protection. Integrated handle for easy transportation on/off the vehicle. Marinized for salt water purposes. See table for installation location and requirements. 	
SR 5.5 Gal (21 L) LinQ Bag	G2, G2L, G2S	860202449	960 zł
	<ul style="list-style-type: none"> Semi-rigid expandable bag. 5.5 gal (21 L) capacity. See table for installation location and requirements. 		
LinQ 4.5 Gal (17 L) Sport Bag	G2, G2L, G2S	860202447	827 zł
	<ul style="list-style-type: none"> 4.5 gal (17 L) capacity. Rigid bottom, semi-rigid top. See table for installation location and requirements. 		

LinQ ACCESSORIES WITH 36" BASE

LinQ 12 Gal (45 L) Cargo Box	G2 (front only for 6x6 & MAX models 2013-2014), G2L, G2S	715003879	1 185 zł
	<ul style="list-style-type: none"> • LinQ mounted for easy on, easy off installation. • Holds cargo safely and securely while riding. • See table for installation location and requirements. 		
LinQ 23 Gal (86 L) Trunk Box	G2 (except 6x6 models), G2L, G2S	715004923	1 550 zł
	<ul style="list-style-type: none"> • LinQ mounted for easy on, easy off installation. • Lockable and weather-resistant. • Holds cargo safely and securely while riding. • Comfort pads for passenger. • See table for installation location and requirements. 		
LinQ 32 Gal (121 L) Trunk Box	G2 (except MAX models & 6x6), G2S	715001747	2 076 zł
	European Version (EC compliant)	715001748 • No rear tail light	1 908 zł
<ul style="list-style-type: none"> • LinQ Retrofit Adaptor Plate (715001334) is required for G1 models. • Trunk Box Panels available in many colors to match your vehicle (sold separately). • See table for installation location and requirements. 			
LinQ 32 Gal (121 L) Trunk Box for Outlander Max	G2 (MAX models only except 6x6 models)	715001749	2 573 zł
	European Version (EC compliant)	715001750 • No rear tail light	2 261 zł
<ul style="list-style-type: none"> • Passenger comfort is ensured on active rides as well as longer recreational rides thanks to the ergonomically designed passenger padding comfort-fitted with a portion made of closed cell foam that won't absorb water. • Very easy to embark even when driver is seated. • Trunk Box Panels available in many colors to match your vehicle (sold separately). 			
LinQ 32 Gal (121 L) Trunk Box Panels	G2 (except 6x6 models), G2S	<ul style="list-style-type: none"> ■ 715001391 • Black ■ 715001392 • Yellow ■ 715001395 • Viper Red □ 715002481 • White ■ 715002480 • Light Grey 	<ul style="list-style-type: none"> ■ 715002984 • Octane Blue ■ 715002985 • Manta Green ■ 715002986 • Can-Am Red ■ 715006119 • Orange Crush ■ 715006120 • Squadron Green ■ 715007074 • Tundra Green
	<ul style="list-style-type: none"> • Color panels to match the LinQ 32 gal (121 L) LinQ Trunk Box to your vehicle. 		
LinQ 32 Gal (121 L) Trunk Box Panels	EUROPEAN VERSION (EC compliant)	<ul style="list-style-type: none"> ■ 715001397 • Black ■ 715001398 • Yellow ■ 715006124 • Viper Red □ 715002483 • White 	<ul style="list-style-type: none"> ■ 715002482 • Light Grey ■ 715006122 • Manta Green ■ 715006121 • Can-Am Red ■ 715006123 • Orange Crush
<i>(Not illustrated)</i>	<ul style="list-style-type: none"> • Color panels to match the LinQ 32 gal (121 L) LinQ Trunk Box to your vehicle. • No rear tail light. 		
Camo Decals for Black Trunk Box Panels	<ul style="list-style-type: none"> ■ 715002975 • Mossy Oak Break-Up Country Camo 		<ul style="list-style-type: none"> ■ 715001683 • Next G-1 Vista Camo
<i>(Not illustrated)</i>	<ul style="list-style-type: none"> • Camo pattern perfectly matches your camo vehicle. 		
LinQ 11.5 Gal (43 L) Audio Cargo Box	G2 (front only for 6x6 & MAX models 2013-2014), G2L, G2S	715003018	3 521 zł
	<ul style="list-style-type: none"> • Mounts on/off easily to hold/carry cargo safely and securely. • The Bluetooth enabled receiver and 6.5" (16.5 cm) speakers are smartly concealed and integrated in the cover. • Automatic shut-off function protects your battery by turning the system off after 10 minutes of inactivity. • Backlit control panel perfect for night riding. • Water-resistant speakers. • Delivers the best sound quality on the market to sweeten your ride courtesy of a built-in full range high-efficiency amplifier. • See table for installation location and requirements. 		

LinQ 8 Gal (30 L) Cooler Box	G2 (except 6x6 models), G2S	■ 715004778 • Black ■ 715004698 • Grey	1 931 zł
-------------------------------------	-----------------------------	---	-----------------



- LinQ mounted for easy on, easy off installation.
- Rotomolded construction provides exceptional rigidity and durability.
- Premium-quality foam insulation for optimal ice retention.
- Integrated, fully-removable compartment protects food.
- Robust rubber latches keep the cover tightly closed.
- Weather-resistant.
- Convenient drain plug.
- See table for installation location and requirements.

LinQ Premium Storage Bag by OGIO	G2 (except 6x6 models), G2L, G2S	■ 715002923 • Black ■ 715003248 • Mossy Oak Break-Up Country Camo	2 076 zł 2 457 zł
---	----------------------------------	--	------------------------------------



- LinQ mounted for easy on, easy off installation.
- Holds cargo safely and securely while riding.
- See table for installation location and requirements.

LinQ Low Profile Basket	G2, G2L (front only for MAX & 6x6 models), G2S	715004282	902 zł
--------------------------------	--	------------------	---------------



- Low profile, open basket increases cargo space.
- Perfect for easy access to tools, rope, winch and plow accessories.
- Multiple bungee cord and tie-down anchor points.
- Made of impact-resistant injected polypropylene.
- See table for installation location and requirements.

LinQ Heavy-Duty Basket	G2, G2L (front only for MAX & 6x6 models), G2S	715001215	1 185 zł
-------------------------------	--	------------------	-----------------



- Made of high-strength, low-alloy steel.
- LinQ mount for easy on, easy off installation.
- Can be placed on both front and back racks of vehicle.
- See table for installation location and requirements.

Large Cargo Box	G2, G2L (Except 6x6)	715007001	2 734 zł
------------------------	----------------------	------------------	-----------------



- Rear bed to carry large items.
- Anchor points (D-ring), LinQ fixtures for tool holder, and marks to allow the installation of a 16" accessory.
- Also has a mat for the floor and slot to enable the installation of a divider and a slot for a divider to close the recess on the rear vertical lip.
- It is installed on ATV platforms through the LinQ system and hooks to make it easily installable and removable.

LinQ HOLDERS

LinQ Tool Holder	G2, G2S, G2L	715007358	224 zł
-------------------------	--------------	------------------	---------------







- Ultra-versatile tool holder.
- Convenient swivel-latch allows tools to be stored in any orientation.
- Sold in pairs.

LinQ Gear Grips	G2, G2S, G2L	715005340	497 zł
------------------------	--------------	------------------	---------------



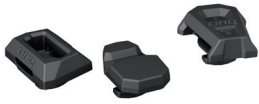

- Durable and flexible grips provide a custom fit for a variety of items from 1" to 4" (2.5 cm to 10 cm) in diameter.
- Heavy-duty design for carrying bows, fishing poles, rakes, farm tools and more.
- Quick-release button opens grip quickly for easy access to gear.
- Heavy-duty base system built for the toughest adventures.
- Make transporting your tools a snap by combining the Gear Grips with the LinQ System.
- 360° orientation.
- Sold in pairs.



LinQ MOUNTING

LinQ Anchor Adaptor Kit	G2, G2S	715004960	317 zł
	<ul style="list-style-type: none"> • Allows the installation of accessories with LinQ base of 16" on LinQ racks. • Tool-less installation and removal. • For G2S, the LinQ Luggage Rack (715001734) is required for installation. 		
LinQ Base	G2L	715002350	103 zł
	<ul style="list-style-type: none"> • Made of polypropylene glass fiber. • Allows you to install LinQ accessories. • Sold in pack of 4. 		
LinQ Lock	G2, G2S, G2L,	860201968	234 zł
	<ul style="list-style-type: none"> • Simple way to lock most LinQ accessories in place. • Retrofits most LinQ accessories. • A cover protects the lock from the elements. • Not compatible with Tool Holder or Working Light. • Pack of one. • Comes with two keys. 		
LinQ Replacement Parts	715001707		130 zł
	<ul style="list-style-type: none"> • Unique mounting fastener usable on any LinQ System accessory. • Tool-less installation and removal. • Sold in pairs. 		





RACKS & HOLDERS

LinQ Rack Extension – 4" (10 cm)	G2, G2S	■ 715001711 • Silver ■ 715001665 • Black	977 zł
	<ul style="list-style-type: none"> • Fits front or rear. • Strong and durable. • Helps keep cargo securely in place. • Easy and tool-less installation thanks to the LinQ System. • Anti-corrosion coating with durable powder coat finish. • LinQ Luggage Rack (715001734) is required for G2S. 		
LinQ Rack Extension – 6" (15 cm)	G2, G2S	■ 715001712 • Silver ■ 715001671 • Black	1 029 zł
	<ul style="list-style-type: none"> • Fits front or rear. • Strong and durable. • Helps keep cargo securely in place. • Easy and tool-less installation thanks to the LinQ System. • Anti-corrosion coating with durable powder coat finish. • LinQ Luggage Rack (715001734) is required for G2S. 		
Rack Extension – 5" (13 cm)	G2L	715001913	595 zł
	<ul style="list-style-type: none"> • Fits front or rear. • Made of carbon steel. • Provides tie-down points to secure cargo on racks. • Easy installation on tubular rack. • Anti-corrosion coating with durable powder coat finish. 		

Rack Extension – 8" (20 cm)	G2L	715001914	671 zł
	<ul style="list-style-type: none"> ▪ Fits front or rear. ▪ Made of carbon steel. ▪ Provides tie-down points to secure cargo on racks. ▪ Easy installation on tubular rack. ▪ Anti-corrosion coating with durable powder coat finish. 		
Rear Aluminum Rack	G2S	715001360	1 087 zł
	<ul style="list-style-type: none"> ▪ 30 lb (14 kg) capacity. ▪ Compact, lightweight aluminum construction. ▪ Engraved Can-Am logo. ▪ Stamped 5052 aluminum center plate. ▪ Easy to install. 		
LinQ Luggage Rack	G2S (except X mr models)	715001734	1 318 zł
	<ul style="list-style-type: none"> ▪ Bolt-on rack. ▪ Enables use of LinQ mounted accessories on the G2S. 		
LinQ Base Plate	G2L	715007273	509 zł
	<ul style="list-style-type: none"> ▪ Enables use of 16" wide LinQ base accessories on G2L to extend cargo options and journey opportunities. ▪ Includes two LinQ bases and hardware. 		
LinQ Base Plate	G2S	715007274	659 zł
	<ul style="list-style-type: none"> ▪ Enables use of 16" wide LinQ base accessories on G2S to extend cargo options and journey opportunities. ▪ Includes two LinQ bases and hardware. 		
Gun Boot Rack	G2L (except MAX models) G2L (MAX models only)	715001918 715001919	648 zł
	<ul style="list-style-type: none"> ▪ Made of steel. ▪ Designed for the tubular rack. ▪ For use with Gun Boot 6.0 Impact by Kolpin. ▪ Can be mounted to either side of the vehicle. 		
Gun Boot 6.0 Impact[†] By Kolpin[†]	G2, G2L	715001419	451 zł
	<ul style="list-style-type: none"> ▪ Extra room for pistol-grip-type weapons and small bipods. ▪ Easily fits firearms up to 51" (130 cm) in total length. ▪ Provides ample room for 2 3/8" (60 mm) scopes. ▪ Hatchback design allows easy access. ▪ Ergonomically designed handle and molded attachment points for sling. ▪ Snap-close cover with locking capability. ▪ Designed to accommodate left and right hand bolt-action rifles and shotguns. ▪ Includes removable, shock absorbing foam and nylon Impact liner for superior interior protection. ▪ Requires appropriate mounting kit for installation. 		
LinQ Gun Boot Rack (Not illustrated)	G2 (except MAX, 6x6 & X mr 1000) G2 (MAX & X mr 1000 models only)	715002112 715002113	769 zł 735 zł
<ul style="list-style-type: none"> ▪ This lightweight Gun Boot Rack can be mounted on either side of your Outlander using the tool-less LinQ System. ▪ For use with Gun Boot 6.0 Impact by Kolpin. 			

Multi-Fit Holder	G2, G2L	715002354 • Single	264 zł
		715001945 • Double	376 zł
	<ul style="list-style-type: none"> Open U-shaped bracket for carrying tools (shovel, axe) and hunting weapons (rifle, bow) that are safely secured, but easily accessible. Easy installation on tubular rack, extension racks, basket or bumpers. For G2, the LinQ Rack Extension (715001711) is required. Sold in pairs. 		
LinQ Gear Grips	G2L	715001421	399 zł
	<ul style="list-style-type: none"> Durable, flexible grips cushion and protect while providing a custom fit for a variety of items from 1" to 4" (2.5 cm to 10 cm) in diameter. Heavy-duty design for carrying bows, fishing poles, rakes, farm tools and more. Quick-release button opens grip quickly for easy access to gear. Heavy-duty base system built for the toughest adventures. Easy installation on tubular racks, extension racks, brackets or bumpers. Sold in pairs. 		

CARGO & STORAGE

Log Bars	G2 (6x6 models only)	715001987	5 087 zł
	<ul style="list-style-type: none"> Log bars allow you to convert the cargo bed into a perfect transport space for 4' (120 cm) timber. The driver's safety is guaranteed by the protective front screen. 		
Hard Top	G2 (6x6 models only)	715002394	4 706 zł
	<ul style="list-style-type: none"> The hard top provides a 116 gal (440 L) cargo box. Locking secures your belongings. The cover raises assisted by gas cylinders. 		
Cargo Box Pool	G2L (6x6 models only)	715005256	1 648 zł
	<ul style="list-style-type: none"> Transforms the flatbed into a large capacity cargo box for increased loading possibilities. Made of durable formed HDPE and shaped to maximize cargo space. Allows access to vehicle's water-resistant rear compartment. Designed for perfect fit and easy installation. 		
Tailgate Extension/Divider	G2 (6x6 models only)	715002017	2 238 zł
	<ul style="list-style-type: none"> The sturdy tailgate extension provides a 10" (25 cm) extension to the cargo space. Thanks to the longer cargo bed, even large loads pose no problem. With the help of LinQ quick locks, the extension also acts as a solid space divider for the cargo bed. 		
Tarpaulin	G2 (6x6 models only)	715002416	1 729 zł
	<ul style="list-style-type: none"> Fitted to cover all of the items in your cargo box thoroughly. Prevents splash from entering cargo box. Easily removable for quick access. 		

18 Gal (70 L) Utility Box

G2 (6x6 models only)

715001999**2 445 zł**

- Wherever you go and whatever you do, this handy 18 Gal (70 L) utility box is your mobile storage.
- The lid keeps your equipment safe from the elements in all conditions.
- Slides under the flatbed with handles for easy access.

Cargo Box Net

G2 (6x6 models only)

715001371**290 zł**

- Solid net designed to hook to the bottom of the cargo box for secure and compact confinement of your cargo.

Tailgate Limiter Kit

G2 (6x6 models only)

715002080**340 zł**

- 2 L-shape brackets that hold the tailgate open horizontally.
- Keeps tailgate flush with the rest of the flatbed for longer oversized cargo.

Soft Storage Bag

G2, G2L, G2S

715003759**786 zł**

- 3 -section bag.
- Transport gear in a weatherproof bag.
- 11.8 gal (45 L) capacity soft cargo bag designed with vehicle's rack in mind to maximize potential storage.
- LinQ Luggage Rack (715001734) is required for G2S.

Storage 2.6 Gal (10 L) Bag**269502121****166 zł**

- Roll-top dry bag for fully protecting your cargo from the elements.
- Fits in rear compartment of your vehicle.

CAN-AM WINDSHIELDS

Deluxe Fairing

G2 (except X mr & 6x6), G2L

■ **715001232** • Black
 ■ **715000935** • Yellow 2000
 ■ **715001231** • Red Viper

■ **715002479** • Light Grey
 ■ **715006125** • Squadron Green
 ■ **715007073** • Tundra Green

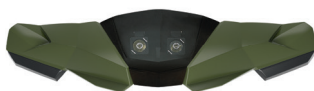
1 110 zł

- Innovative, richly featured wind protection.
- Quick tool-less removal once base brackets are mounted on handlebar.
- Two cup holders.
- Ready for GPS mounting kit.
- Optional mirrors and auxiliary lighting.
- Requires low, high or extra high windshield.
- Tapered Handlebar Adapter Kit is required for vehicles with 1 1/8" (28 mm) tapered aluminum handlebars.

Camo Decals for Black Deluxe Fairing*(Not illustrated)*

Deluxe Fairing

■ **715002976** • Mossy Oak Break-Up Country Camo
 ■ **715001684** • Next G-1 Vista Camo

245 zł

- Camo pattern perfectly matches your camo vehicle.

Tapered Handlebar Adaptor Kit*(Not illustrated)*

Deluxe Fairing

715002470**153 zł**

- Required to install Deluxe Fairing on an Outlander X-TP and on any vehicle equipped with 1 1/8" (28 mm) tapered aluminum handlebars.

Extra High Windshield

Deluxe Fairing

71500936

515 zł

- 16" (41 cm) windshield provides the ultimate protection against the elements while touring.
- For wind protection and winter applications.
- Tool-less installation and replacement.

High Windshield

Deluxe Fairing

715001211

376 zł

- 11" (28 cm) high, for wind protection and winter applications.
- Tool-less installation and replacement.

Low Windshield

Deluxe Fairing

715001227

313 zł

- 6" (15 cm) windshield allows you to keep your vehicle looking sporty while giving you some protection from the elements and the possibility of enjoying directional lighting.
- Tool-less installation and replacement.

ACCESSORIES**Auxiliary Windshield Lighting**

Deluxe Fairing

715003115

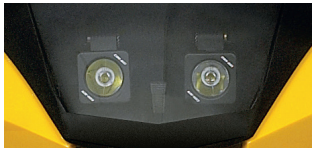
1 764 zł

- 2 premium LED spots for Deluxe Fairing for both increased output and directional lighting.
- 1,800 lumens.
- 2 x 10W LED Cree light kit.
- Long-range illumination up to 350' (107 m), drawing less than 1 amp per light.

Deluxe Mirror Kit

Deluxe Fairing

715002353

317 zł

- Improved mounting system.
- Wide rear view.
- Perfect fit with your Deluxe Fairing.

WINDSHIELD KITS**Extra High Windshield Kit**

G2, G2L, G2S (except X mr models)

715003023

1 208 zł

- Made of polycarbonate with integrated vent to reduce air turbulence and rumble noise at high speeds for a quieter and smoother ride.
- Quick tool-less removal once base brackets are mounted on handlebar.
- Fits straight and tapered handlebars.
- Improved design for enhanced rigidity.
- Steering Cover (709400939) is required for XT and Mossy Oak models.
- 16" (41 cm) windshield.
- For ultimate wind protection and winter applications.

High Windshield Kit

G2, G2L, G2S (except X mr models)

715006382

1 058 zł

- Made of polycarbonate with integrated vent to reduce air turbulence and rumble noise at high speeds for a quieter and smoother ride.
- Quick tool-less removal once base brackets are mounted on handlebar.
- Fits straight and tapered handlebars.
- Improved design for enhanced rigidity.
- Steering Cover (709400939) is required for XT and Mossy Oak models.
- 11" (28 cm) windshield.
- For wind protection and winter applications.

Low Windshield Kit

G2, G2L, G2S (except X mr models)

715003021

856 zł



- Made of polycarbonate with integrated vent to reduce air turbulence and rumble noise at high speeds for a quieter and smoother ride.
- Quick tool-less removal once base brackets are mounted on handlebar.
- Fits straight and tapered handlebars.
- Improved design for enhanced rigidity.
- Steering Cover (709400939) is required for XT and Mossy Oak models.
- 6" (15 cm) windshield.
- Allows you to keep your vehicle looking sporty while giving you some protection from the elements.

HANDLEBARS & MIRRORS

Handlebar Wind Deflectors

G2, G2L, G2S

■ 715000525 • Black / Yellow
■ 715000537 • White / Black
■ 715001706 • Black / Black
■ 715000733 • Yellow / Black
■ 715003811 • Can-Am Red / Black

■ 715003812 • Manta Green/Black
■ 715003813 • Orange / Black
■ 715003814 • Octane Blue / Black
■ 715006117 • Squadron Green / Black
■ 715006118 • Viper Red / Black

134 zł



- Rugged injected plastic construction with Can-Am logo.
- Include removable cap for air flow adjustment.
- Mounting kit sold separately.

Passenger Wind Deflectors

G2 and G2L (MAX models only)

715001669

428 zł



- These wind deflectors fit on the passenger handles and provide greater comfort while riding.
- Easy to install and remove.

Full Wrap Aluminum Mounting Kit

G2, G2L, G2S

715001378

474 zł



- Lightweight black die cast aluminum construction.
- Includes complete hardware.
- Handlebar wind deflectors sold separately.

Short Aluminum Mounting Kit

G2, G2L, G2S

715001379

308 zł



- Lightweight black die cast aluminum construction.
- Includes complete hardware.
- Handlebar wind deflectors sold separately.

Mirror Kit for Handlebar Wind Deflectors

Handlebar Wind Deflectors

860200080

127 zł



- Do not fit with Full Wrap Aluminum Mounting Kit (715001378).
- Sold in pairs.

Aluminum Tapered Handlebar

G2, G2L, G2S

715000550

544 zł



- 7/8" - 1 1/8" (22 mm - 28 mm) tapered handlebar made of 6061-T6 aluminum.
- Includes all hardware, center steering foam and cover.

Xt Handlebar Protector Kit

G2, G2L

703100352

491 zł

- Not compatible with Mud Strap (715003053).

Mirrors Left - 3/8" (10 mm)

G2, G2L, G2S

709400406

125 zł

- True vision surface 5" x 3" (13 cm x 8 cm).
- Matte finish.
- Stem includes 3/8" (10 mm) thread.
- Bracket (715000190) is required for installation on DS 450.
- Bracket not required for installation on Outlander and Renegade.

Mirrors Right - 3/8" (10 mm)*(Not illustrated)*

G2, G2L, G2S

709400523

133 zł

- True vision surface 5" x 3" (13 cm x 8 cm).
- Matte finish.
- Stem includes 3/8" (10 mm) thread.
- Bracket (715000190) required except for vehicles with right hand brake.

Handlebar Mirrors

G2, G2L, G2S

715005366

302 zł

- Adjustable handlebar mounted convex mirrors.
- The convex surface allows improved visibility with a wider field of view.
- Doesn't require a windshield or fairing to be mounted.

SEATS

Driver Backrest

G2 2015 & up, G2L (MAX models only, except 6x6 models)

715003942

1 208 zł

G2L (except MAX models)

715003941

1 208 zł

G2 (except 6x6 & MAX models)

715003940

1 185 zł

G2 (6x6 models only, except Max)

715003611

1 070 zł

- Provides the rider's back with that extra support that makes riding that extra mile way more comfortable.
- Adjusts horizontally to match the driver's height and preference.
- Mounts and locks in firmly onto the vehicle.

Outlander Max Passenger Seat Kit

G2 2015 and up, G2L (MAX models only)

715002373

3 214 zł

- Perfect to replace used or damaged passenger seat.

HMWPE SKID PLATES

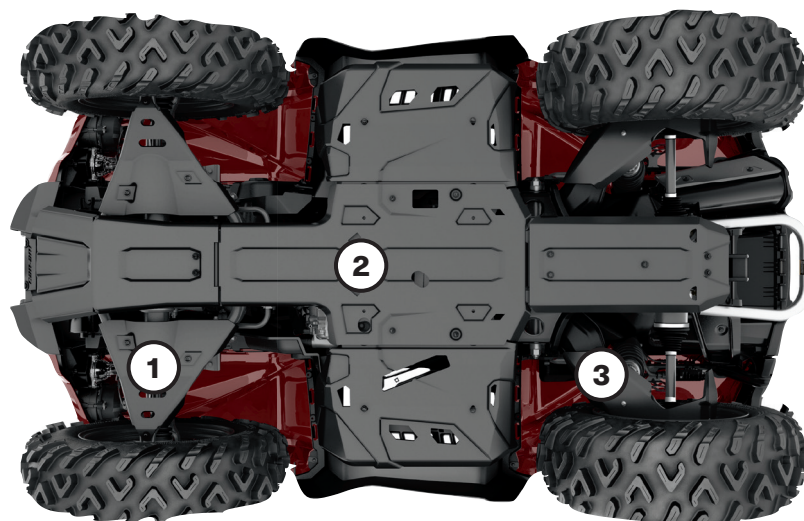

Our Plastic Plates glide smoothly and silently over obstacles, offering great protection in rough terrain. Made of ¼" (6 mm) thick abrasion-resistant thermoformed High Molecular Weight Polyethylene (HMWPE).

- Lighter than aluminum.
- High impact strength.
- Superior stress crack resistance.

OUTLANDER, RENEGADE									
		G2				G2L		G2S	
2016 & PRIOR		2017-2018		2019 & UP				2017-2018 MODELS	2019 & UP
Except MAX & X mr 1000R models	MAX & X mr 1000R models only	Except Max & X mr 1000R models	MAX & X mr 1000R models only	Except MAX & X mr 1000R models	MAX & X mr 1000R models only	Except MAX models	MAX models only		

HMWPE SKID PLATE PROTECTION KIT

715004214	715004215	715004209	715004210	715004806	715004807	715004211	715004212	715004213	715004809
-----------	-----------	-----------	-----------	-----------	-----------	-----------	-----------	-----------	-----------

INDIVIDUAL HMWPE SKID PLATES

① A-Arm Protectors	715002924 562 zł	715002924 562 zł	715002924 562 zł	715002924 562 zł	715004822 562 zł	715004822 562 zł	715002924 562 zł	715002924 562 zł	715002924 562 zł	715004822 562 zł
② Underbelly Plates <small>Footwell portion not compatible with Renegade X mr</small>	715002926 2 060 zł	715002927 2 175 zł	715002926 2 060 zł	715002927 2 175 zł	715002926 2 060 zł	715002927 2 175 zł	715002928 2 060 zł	715002929 2 175 zł	715002974 2 060 zł	715002974 2 060 zł
③ Trailing Arm Protectors	715002925 500 zł	715002925 500 zł	715003466 562 zł	715003466 562 zł	715004823 562 zł	715004823 562 zł	715003466 (2015 to 2020 models only) 562 zł	715003466 (2015 to 2020 models only) 562 zł	715003466 562 zł	715004823 562 zł

ALUMINUM SKID PLATES

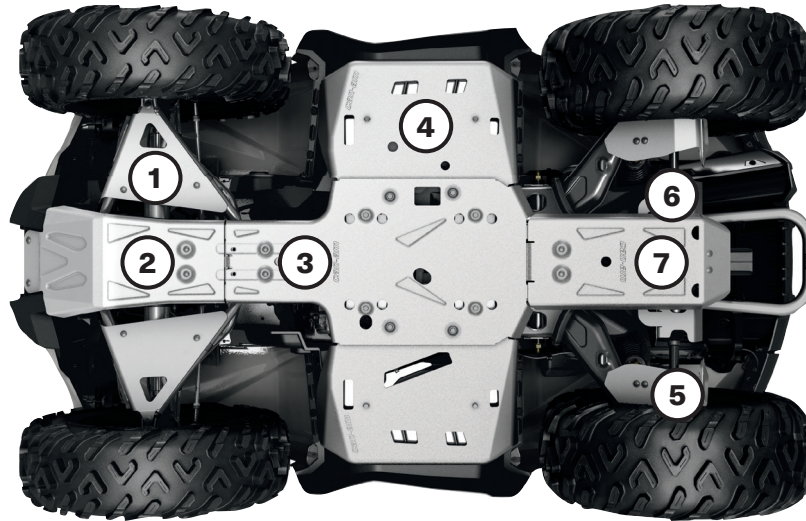

For ultimate durability and strength, all our Aluminum Skid Plates are made with $\frac{3}{16}$ " (4.5 mm) thick High Strength 5052 H32 Aluminum.

- Ultimate durability.
- High strength.

	OUTLANDER							
	G2				G2L			
	2016 & PRIOR		2017-2018		2019 & UP		ANY YEAR	
	Except MAX & X mr 1000R models	MAX & X mr 1000R models only	Except MAX & X mr 1000R models	MAX & X mr 1000R models only	Except MAX & X mr 1000R models	MAX & X mr 1000R models only	Except MAX models	MAX models only
ALUMINUM SKID PLATE PROTECTION KIT								
	715002137	715002138	715004197	715004198	715004804	715004805	715004199	715004200
INDIVIDUAL ALUMINUM SKID PLATES								
① A-Arm Protectors	715001667 650 zł	715001667 650 zł	715001667 650 zł	715001667 650 zł	715004820 630 zł	715004820 630 zł	715001667 650 zł	715001667 650 zł
② Front Skid Plate	715000926 364 zł	715000926 364 zł	715000926 364 zł	715000926 364 zł	715000926 364 zł	715000926 364 zł	715001906 526 zł	715001906 526 zł
③ Central Skid Plate	715002078 526 zł	715002078 526 zł	715002078 526 zł	715002078 526 zł	715002078 526 zł	715002078 526 zł	715002078 526 zł	715002078 526 zł
④ Footwell Protector Plates	715000922 647 zł	715000922 647 zł	715000922 647 zł	715000922 647 zł	715000922 647 zł	715000922 647 zł	715000922 647 zł	715000922 647 zł
⑤ Trailing Arm Protectors	—	—	715003741 562 zł	715003741 562 zł	715004821 583 zł	715004821 583 zł	715003741 2015 to 2020 562 zł	715003741 2015 to 2020 562 zł
⑥ Rear Differential Protectors	715000920 306 zł	715000920 306 zł	715000920 306 zł	715000920 306 zł	715000920 306 zł	715000920 306 zł	715000920 306 zł	715000920 306 zł
⑦ Rear Skid Plate	715002028 364 zł	715002029 526 zł	715002028 364 zł	715002029 526 zł	715002028 364 zł	715002029 526 zł	715002028 364 zł	715002029 526 zł

ALUMINUM SKID PLATES

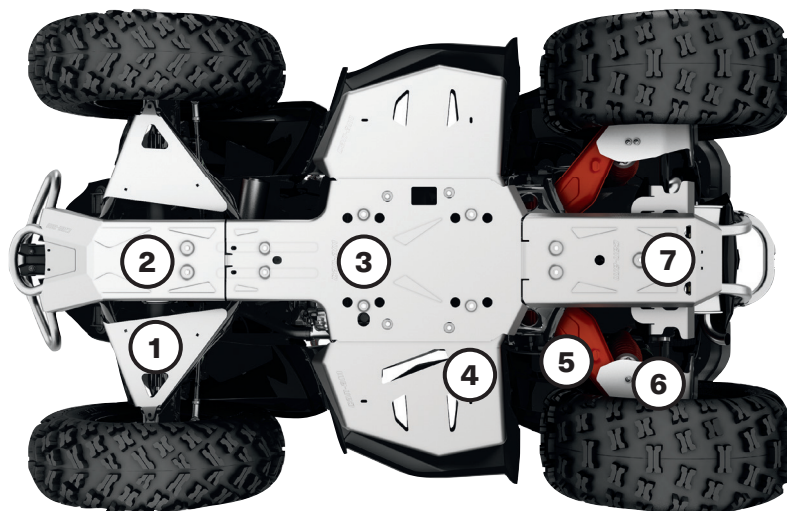

For ultimate durability and strength, all our Aluminum Skid Plates are made with $\frac{3}{16}$ " (4.5 mm) thick High Strength 5052 H32 Aluminum.

- Ultimate durability.
- High strength.

	RENEGADE		
	G2S		
	2016 & PRIOR	2017-2018	2019 & UP
ALUMINUM SKID PLATE PROTECTION KIT			
<i>Not compatible on X.mr models</i>	715002139	715004201	715004808
INDIVIDUAL ALUMINUM SKID PLATES			
② A-Arm Protectors	715001667 650 zł	715001667 650 zł	715004820 630 zł
② Front Skid Plate	715000925 364 zł	715000925 364 zł	715000925 364 zł
③ Central Skid Plate	715002078 526 zł	715002078 526 zł	715002078 526 zł
④ Footwell Protector Plates <i>Not compatible on X.mr models</i>	715001359 801 zł	715001359 801 zł	715001359 801 zł
⑤ Trailing Arm Protectors		715003741 562 zł	715004821 583 zł
⑥ Rear Differential Protectors	715000920 306 zł	715000920 306 zł	715000920 306 zł
⑦ Rear Skid Plate	715002028 364 zł	715002028 364 zł	715002028 364 zł

HMWPE & ALUMINUM SKID PLATES

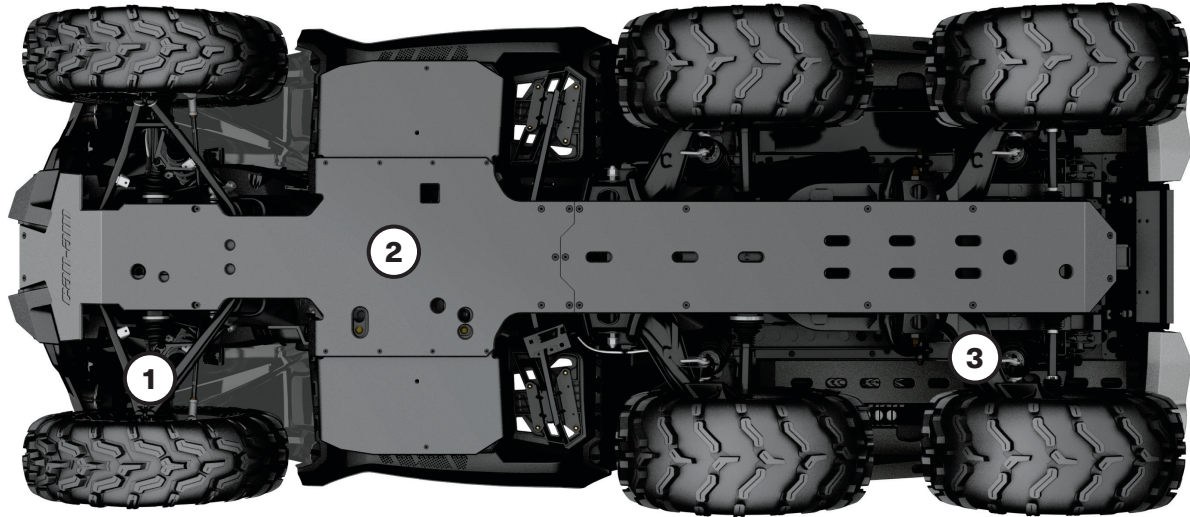

Our Plastic and Aluminum Plates glide smoothly and silently over obstacles, offering great protection in rough terrain.

HMWPE

Made of ¼" (6 mm) thick abrasion resistant thermoformed High Molecular Weight Polyethylene (HMWPE).

- Lighter than aluminum.
- Superior stress crack resistance.
- High impact strength.

ALUMINUM

Made with High Strength ⅜" (4.5 mm) thick 5052 H32 Aluminum.

- Ultimate durability.
- High strength.

	OUTLANDER 6X6			
		G2 6x6		G2L 6x6
	2016 & PRIOR	2017 - 2018	2019 & UP	ANY YEAR
INDIVIDUAL HMWPE SKID PLATES				
① HMWPE A-Arm Protectors	715002924 562 zł	715002924 562 zł	715004822 562 zł	715002924 562 zł
② HDPE Full Underbelly Skid Plate	715003646 (Except MAX) 2 342 zł	715003646 2 342 zł	715003646 (Except MAX) 2 342 zł	715005259 (MAX Only) 2 264 zł
	715003647 (MAX Only) 2 456 zł	715003647 2 456 zł	715003647 (MAX Only) 2 456 zł	
③ HMWPE Trailing Arm Protectors	715002925 500 zł	715003466 562 zł	715004823 562 zł	715003466 (2020 models & prior only) 562 zł
INDIVIDUAL ALUMINUM SKID PLATES				
① Aluminum A-Arm Protectors	715001667 650 zł	715001667 650 zł	715004820 650 zł	715001667 650 zł
② Aluminum Full Underbelly Skid Plate				
③ Aluminum Trailing Arm Protectors		715003741 562 zł	715004821 583 zł	715003741 (2015 to 2020 models only) 562 zł

BUMPERS & GUARDS

BUMPERS

Expedition Front Bumper	G2, G2L (except X mr models)	715007233	1 289 zł
--------------------------------	------------------------------	------------------	-----------------



- Made of 1.5" profiled steel tubes for complete protection of the vehicle's front.
- Protects and doesn't obstruct the vehicle's headlights.
- Integrated mounting spots for lights.
- Inside and outside anticorrosion coating with a durable powder coat finish.

Expedition Rear Bumper	G2, G2L (except X mr models)	715007234	1 185 zł
-------------------------------	------------------------------	------------------	-----------------



- Made of 1.5" profiled steel tubes for complete protection of the vehicle's rear.
- Protects and doesn't obstruct the vehicle's taillights.
- Inside and outside anticorrosion coating with a durable powder coat finish.
- G2 base and DPS rear bumper installation requires 705008164 and 705008165.

XT Front Bumper	G2	715004837	925 zł
------------------------	----	------------------	---------------



- Provide additional protection against obstacles.
- Tough and durable, can be added on base Outlander model to convert vehicle into XT model.
- Standard on XT, XT-P, Mossy Oak and Limited models.
- Large tube construction with textured black finish and metal corners.

XT Rear Bumper	G2	715004920	925 zł
-----------------------	----	------------------	---------------



- Provide additional protection against obstacles.
- Tough and durable, can be added on base Outlander model to convert vehicle into XT model.
- Standard on XT, XT-P, Mossy Oak and Limited models.
- Large tube construction with textured black finish and metal corners.

XT Front Bumper	G2L	715001910	688 zł
------------------------	-----	------------------	---------------



- Winch compatible.
- Large tube construction.
- Protects vehicle against obstacles.
- Standard on XT models.

XT Rear Bumper	G2L	715001911	544 zł
-----------------------	-----	------------------	---------------



- Large tube construction.
- Protects vehicle against obstacles.
- Standard on XT models.

Extreme Front Bumper	G2	715001286*	1 341 zł
	G2L	715004279	1 231 zł





- Ultra-sturdy build.
- Enhances front-vehicle protection.
- Compatible with XT Front Bumper.
- Fits the Apache™ 360 Track System (when side panels are removed).

*Not compatible with Front Hitch.

Complete Rancher Protection Kit	G2, G2L (except X mr & 6x6 models)	715003463	- zł
	<ul style="list-style-type: none"> • These heavy-duty bumpers and fender guards are designed to pull double duty: protect your ATV and anything it comes in contact with, while also enhancing the look of your ATV. • Made tough and designed to deliver a rugged appearance, together they offer front, rear and full side protection for farmer, rancher and forestry applications. • Requires Body Side Protector Extensions (715003460) for installation on MAX models. • This kit includes: <ul style="list-style-type: none"> – Rancher Front Bumper (715003461). – Rancher Rear Bumper (715003462). – Body Side Protector (715003459). 		

Rancher Front Bumper	G2, G2L (except X mr models)	715003461	1 492 zł
	<ul style="list-style-type: none"> • The low front end protection and plates allow you to use your ATV within cattle herds and guard the safety of both the vehicle and the animals. • The flat front portion facilitates gently prodding cattle or pushing light objects, e.g. closing a fence. • The full frontage coverage extends to provide an extra layer of defense to your headlights and radiator. • Inside and outside anti-corrosion coating with durable powder coat finish. • Not compatible with track systems, plows and front hitch. 		

Rancher Rear Bumper	G2, G2L (except 6x6 models)	715003462	1 266 zł
	<ul style="list-style-type: none"> • Ideal for using your ATV within cattle herds and guarding the safety of both the vehicle and the animals. • Coverage extends to provide an extra layer of defense to your tail lights. • Inside and outside anti-corrosion coating with durable powder coat finish. • Not compatible with track systems. 		

Renegade Extreme Front Bumper	G2S	715002469	1 185 zł
	<ul style="list-style-type: none"> • Enhanced vehicle front protection. • Required as a mounting point for Radiator Relocator (715001929). 		

GUARDS

Body Side Protector	G2, G2L, with Rancher bumpers (except X mr & 6x6 models)	715003459	1 625 zł
	G2 with XT bumpers (except 6x6 models)	715004940*	1 671 zł
	G2L with XT bumpers (except X mr & 6x6 models)	715003614	1 775 zł

	<ul style="list-style-type: none"> • The heavy-duty fender guard designed to pull double duty, protecting your ATV and also enhancing the look of your ATV. • Made tough and designed to deliver a rugged appearance, this fender guard offers full side protection for farmer, rancher and forestry applications. • Built of durably bold 1.25" (3 cm) diameter steel-tube construction, with inside and outside anti-corrosion coating with durable powder coat finish. • Not compatible with Self Clearing Footwell. • XT Front and Rear Bumpers or Rancher Front and Rear Bumpers are required for installation. • Requires Body Side Protector Extensions (715003460) for installation on MAX models. <p><i>*Not compatible with Front and Rear Rancher bumpers.</i></p>		
---	---	--	--

Body Side Protector Extensions <i>(Not illustrated)</i>	G2, G2L (MAX models only)	715003460	321 zł
<ul style="list-style-type: none"> • This specially designed extension for the Body Side Protector is made specifically to fit and seamlessly integrate into the look of Outlander MAX models. 			

Mud Flaps	G2 (with stock fender flares)	715007089	256 zł
	<ul style="list-style-type: none"> • Keeps mud, snow and debris out of cargo area and protects trailer and vehicles behind you. • Adds aesthetic appearance to your vehicle. • Requires stock fender flare. • Sold in pairs. 		

Fender Flares	G2 2012-2018 (except with 30" tires) (except 6x6 models)	715001764*	648 zł
	G2 2019 & up (with 30" tires) (except 6x6 models)	715004250**	648 zł
	G2L	715001909***	648 zł
	G2L European vehicles only 2015 & up	715004487	700 zł



- Kit designed to deliver extra protection from dirt and debris, therefore a must if you enjoy riding in the mud.
- Made of injected plastic that hugs your vehicle fenders perfectly.
- Gives vehicle added flair for that rugged cool look.
- Includes front and rear extensions and all mounting hardware.

*Comes stock on G2 models 2019 & up (except X mr models).

**Standard on G2 X mr 1000R.

***Not compatible with European vehicles.

Fender Flare Extensions	G2 (except 6x6 models)	715005111*	1 087 zł
	G2L	715003615**	



- Block terrain debris from kicking up onto you as you ride or damaging your vehicle thanks to these extra-large Fender Flare Extensions, which also include mud flaps for added protection from mud/snow, especially when riding with track kits.
- Made of High Molecular Weight Polyethylene (HMWPE) for advanced abrasion resistance.
- Include front and rear extensions.

*Must be used with Fender Flare for G2 (715001764).

**Must be used with Fender Flare for G2L (715001909).

Fender Flares	G2S (except X mr models)	705012695	1 018 zł
----------------------	--------------------------	------------------	-----------------



- Integrated extended Fender Flares for sporty look and full body protection from dirt and water.
- Include front and rear extensions and all mounting hardware.

Flatbed Protection Tubes	G2 (6x6 models only)	715002030	2 266 zł
---------------------------------	----------------------	------------------	-----------------



- Bolt-on bumpers for the sides of the 6x6 flatbed.
- Protect the exterior plastic components of the flatbed from rocks, trees and other obstacles when traversing enclosed areas or loading cargo onto the bed.

Flatbed Protection Tubes	G2L (6x6 models only)	715005266	1 561 zł
---------------------------------	-----------------------	------------------	-----------------



- Bolt-on bumpers for the sides of the 6x6 flatbed.
- Protect the exterior plastic components of the flatbed from rocks, trees and other obstacles when traversing enclosed areas or loading cargo onto the bed.

LIGHTS & ELECTRICAL

Heated Grips & Thumb Throttle Combo	G2, G2L, G2S (except 2020 & up models equipped with 850 engine and 2019 & up models with 1000R engine, T Category models)	715003250 Not compatible with Intelligent Throttle Control (ITC)	1 324 zł
Heated Grips & Thumb Throttle Combo	G2, G2L, G2S (2020 & up models equipped with 850 engine and 2019 & up models with 1000R engine, T Category models)	715008739 Compatible with Intelligent Throttle Control (ITC)	1 324 zł
	<ul style="list-style-type: none"> • LED dimmer facilitates reading temperature settings. • 4 temperature settings with individual controls for thumb and grips. • Returns to previous heat setting. • One-touch shutdown. • Wiring Cable is required for installation on G2L models only. 		
Wiring Cable <i>(Not illustrated)</i>	G2L	710004567	55 zł
<ul style="list-style-type: none"> • Required for installation of Heated Hand Grips & Throttle Combo. 			
Heated Visor Outlet	G2, G2L	715001246	283 zł
	<ul style="list-style-type: none"> • Strategically positioned on vehicle to maintain your agility. • Optional visor outlet that delivers fog-free riding. • Quick and easy installation. • Sold individually. • Heated Visor not included. 		
Heated Passenger Grips & Visor Outlet	G2, G2L (MAX models only)	715001926	1 208 zł
	<ul style="list-style-type: none"> • Replace your stock passenger handles. • Dual temperature switch integrated into seat arm for 3-zone heated handles and grips. • Heated visor outlet integrated into seat arm. 		
USB Power Outlet Kit	G2, G2L, G2S	219400510	183 zł
	<ul style="list-style-type: none"> • Recharges your electronic devices while riding* (smartphone, MP3, heating gear, etc.). • Dual port USB connectors. • The power outlet is not capable of recharging all device types while riding. 		
Seat Heater	G2, G2S, G2L	715007211	665 zł
	<ul style="list-style-type: none"> • 25 W seat heater delivers chill-free riding comfort. • One temperature only. • Heated pad and electrical harness only. • Durable seat cover (715007212) is required for the installation. 		
Heavy-Duty Seat Cover	G2, G2S, G2L	715007212	256 zł
	<ul style="list-style-type: none"> • Heavy-duty materials to cover and protect the seat. • Abrasion- and tear-resistant. • Simply installs by stretching around the original seat; the elastic holds the cover securely in place. 		

Electronic Device Holder	G2, G2L (except 6x6 & X mr models)	715004919	671 zł
	<ul style="list-style-type: none"> Robust injected-polypropylene construction allows for the right fit and easy installation. Adjustable unit safely holds smartphones or small tablets with a length or width measuring between 2.9" (7.5 cm) and 5.1" (13.0 cm) with or without protective case. Integrated storage (0.6 gal / 2.1 L). Guiding wire grooves to pass charging cable through the lid. Possibility of relocating 12V power outlet or installing USB outlet in storage compartment (USB power outlet sold separately). Not compatible with windshields and Snorkel Kit. 		
3.5" (9 cm) LED Lights (2 X 14W) LED Driving Lights	G2, G2L	715003666	1 007 zł
	<ul style="list-style-type: none"> 14W LED lights producing 1,260 lumens each. Equipped with 6 high power LEDs in a heavy-duty die cast aluminum housing. Features 2 attachment points — if one attachment point fails due to a collision, rotate to the next channel point and re-mount the light. Sold in pairs. EC compliant. Spot lens for a narrow and long light beam spread, ideal when driving at higher speeds. Expedition Front Bumper (715007233) and Light Power Cable (715007275) required for installation. 		
3.5" (9 cm) LED Lights (2 X 14W) LED Flood Lights	G2, G2L	715003665	1 007 zł
	<ul style="list-style-type: none"> 14W LED lights producing 1,260 lumens each. Equipped with 6 high power LEDs in a heavy-duty die cast aluminum housing. Features 2 attachment points — if one attachment point fails due to a collision, rotate to the next channel point and re-mount the light. Sold in pairs. EC compliant. Flood lens for a wide light beam spread, ideal for working applications like plowing or for cornering, dusty or foggy riding conditions. Expedition Front Bumper (715007233) and Light Power Cable (715007275) required for installation. 		
10" (25 cm) Double Stacked LED Light Bar (60 Watts)	G2, G2L	715002933	1 453 zł
	<ul style="list-style-type: none"> Equipped with 12 5W Cree LEDs. 5,400 lumens. Rugged and waterproof. Packs a big punch for its size. EC compliant. Expedition Front Bumper (715007233) and Light Power Cable (715007275) required for installation. 		
Light Power Cable <i>(Not illustrated)</i>	G2, G2L	715007275	555 zł
<ul style="list-style-type: none"> Required for installation of the 10" (25 cm), 15" (38 cm) single and double stacked LED light bars, and the 4" (10 cm) round LED lights. 			
Bluetooth Handlebar Soundbar by Mtx	G2, G2L, G2S	219400840	2 289 zł
	<ul style="list-style-type: none"> Bluetooth speaker with the unbeatable convenience of fingertip control. Rugged IP66-rated weather-resistant speaker designed for outdoor use. Driven by 150 watts of quality audio power. Seamless integration and operation from Bluetooth enabled devices. Includes input, ground and ignition wires, plus auxiliary port and 3.5" (8.89 cm) connector cable. Not compatible with XT Handlebar Protector Kit. EC compliant. <p><i>Note: We recommend you use 320 Kbps MP3 - 192-256 Kbps AAC or AIFF, WAV formats to match the potential of the speaker. More compressed formats will probably have degraded sound quality.</i></p>		
Multi Position Light Mount Kit	G2, G2L, G2S	715004274	457 zł
	<ul style="list-style-type: none"> Multi-position plastic clamps that fit on various tubing sizes: 0.75" to 1.5" (19 mm to 38 mm). Required for the installation of the 2" (5 cm) Square LED Lights (2 x 10W). Kit includes tube clamp mounts and power cables. 		
Baja Designs High Beam Kit	G2	715004284	3 267 zł
	<ul style="list-style-type: none"> Thanks to their direct bolt-on and plug-and-play installation right into the original high beam location, upgrading from your stock high beam lights to these powerful Baja Designs Squadron Pro LED Lights becomes child's play. Each spot is equipped with 4 Cree LEDs producing 4,900 lumens at 40 watts. Driving/Combo light pattern for smooth blend of light for both near field applications and distance. 		

2" (5 cm) Square LED Lights (2 X 10 Watts)

G2, G2L, G2S

715004293

842 zł



- 2 x 900 lumens 10W LED Cree light kit.
- Long-range illumination up to 350' (107 m), drawing less than 1 amp per light.
- Multi-Position Light Mount Kit is required for installation.
- Not EC compliant.

Auxiliary Windshield Lighting

Deluxe Fairing

715003115

1 764 zł



- 2 premium LED spots for Deluxe Fairing for both increased output and directional lighting.
- 1,800 lumens.
- 2 x 10W LED Cree light kit.
- Long-range illumination up to 350' (107 m), drawing less than 1 amp per light.

RAM® LED Spotlight

G2, G2L, G2S

710005423

711 zł



- 540 lumens LED light (9W) heavy-duty spotlight standard-equipped with 1" (2.5 cm) diameter rubber-coated double ball and socket system.

Center Console Day Light

G2S (except X mr)

715000691

255 zł



- Mountable on top end of center console.
- Enhances look of vehicle.

Battery Charger/Maintainer

715005061

- zł



- Keeps stored lead-acid batteries charged.
- Charges and maintains small batteries.
- Microprocessor controlled multi-stage charging for added precision, safety and battery life.
- Automatically detects 6- or 12-volt batteries.
- Reverse hook-up protection helps protect battery and charger from damage.
- Auto-voltage detection.
- Press the display button to show the charge progress.
- Content: 3 amp battery charger, clamp adapter, DC adapter, 24" (61 cm) fused ring leads harness with weather cap, owner's manual.
- Not EC compliant.

Jump Starter

715005062

- zł



- IPX3 water-resistant and enclosed output ports.
- 4 LED battery indicators for easy read on battery charge level.
- Compact design, will conveniently fit in your backpack, glove box or any other storage compartment.
- 2.4A + 1A/5V USB ports for fast charging of all USB devices.
- Smart cable provides protection against reverse polarity, short circuit, low voltage, high temperature and reverse charging.
- Built-in LED light (3 modes).
- Content: 300CA jump starter, SA858 smart cable clamp, MC-USB to USB charging cable, travel bag, user manual.
- Not EC compliant.

Quick Connect Battery Cable

715005408

40 zł



- Quickly and easily connect and charge different items with your charger.
- Included in the Battery Charger/Maintainer (715005061).
- Sold individually.

Quick Connect Cable with Battery Indicator

715006055

103 zł

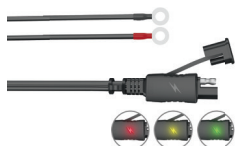

- Quickly and easily connect and charge different batteries with your charger.
- 3-color LED indicator provides constant battery health indication.
- Sold individually.

Garmin[†] Montana[†] 680t GPS

G2, G2L, G2S

715002830

715003456*European Version

4 307 zł

4 272 zł



- Rugged and waterproof, the Montana 680T is element-proof.
- 4" (10.2 cm) dual-orientation, sunlight-readable touchscreen and glove-friendly touchscreen display, to give you vivid colors and high-resolution images.
- 8-megapixel autofocus camera automatically geotags photos.
- Tracks both GPS and GLONASS satellites for improved positioning and typically faster fixes.
- Preloaded TOPO maps, plus 1-year BirdsEye Satellite Imagery subscription.
- 3-axis compass with barometric altimeter.
- Specific GPS cradle included (vehicle mounting kit required).
- Includes a preloaded map for US.

*EC compliant.

*Includes preloaded European recreation maps.

Canadian Map for Garmin Montana 680t GPS

(Not illustrated)

710005065

925 zł

- Additional and readily-programmable Canadian basemap for Garmin Montana 680T GPS system.
- Requires Garmin Montana 680T GPS (715002830).

GPS RAM[†] Mount for Handlebar

G2, G2L, G2S

715001985

340 zł



- Convenient bracket for installing the Garmin Montana GPS (not included) onto your unit's handlebar.

Digitally Encoded Security System (D.E.S.S.) Green Key

G2, G2S (2018 & up)

710005232

219 zł



- Anti-theft technology, Digitally Encoded Security System (D.E.S.S.) key snaps on easily on the vehicle and provides riders easy and quick starts every time.
- The key communicates with the vehicle wirelessly so the vehicle starts only when the key code matches the vehicle, for ultimate peace of mind.
- The Programmable D.E.S.S. Key can also be programmed to 3 modes:
 - Work mode: Limits vehicle speed to 40 kph (25 mph) but does not limit engine torque.
 - Normal mode: Limits vehicle speed to 70 kph (44 mph) and 50% torque reduction.
 - Performance mode: No restrictions.

WINCHES

CAN-AM HD WINCHES

Can-Am HD 2500 Winch	G2, G2L	715006414	1 384 zł
----------------------	---------	-----------	----------



- Heavy-duty four-way roller fairlead.
- Ergonomic clutch handle.
- Rugged all-steel gears and bushings provide more torque and longer life.
- Automatic 100% load-holding brake.
- Sealed solenoid for all-weather protection.
- Wired Remote Control sold separately.
- Plug-and-play wiring and attachment brackets.
- Weather-sealed handlebar-mounted switch.
- Pulling strength capability of 2,500 lb (1,134 kg).
- 50 ft. of 3/16" (15.2 m of 4.8 mm) wire steel cable.
- EC-compliant.
- Wire harness (715002453) required for G2L.

Can-Am HD 3500 Winch	G2, G2L	715006415	1 509 zł
----------------------	---------	-----------	----------



- Heavy-duty four-way roller fairlead.
- Ergonomic clutch handle.
- Rugged all-steel gears and bushings provide more torque and longer life.
- Automatic 100% load-holding brake.
- Sealed solenoid for all-weather protection.
- Wired Remote Control sold separately.
- Plug-and-play wiring and attachment brackets.
- Weather-sealed handlebar-mounted switch.
- Pulling strength capability of 3,500 lb (1,588 kg).
- 50 ft. of 3/16" (15.2 m of 4.8 mm) wire steel cable.
- EC-compliant.
- Wire harness (715002453) required for G2L.

WARN® VRX WINCHES

WARN VRX 25 Winch	G2, G2L, G2S	715006107	2 217 zł
-------------------	--------------	-----------	----------



- Extreme IP68-rated waterproof sealing keeps the elements out.
- Durable all-metal construction.
- Black powder-coated finish and stainless-steel fasteners for corrosion resistance.
- Robust new clutch design based on 70+ years of WARN 4WD hub lock know-how.
- Handlebar-mounted rocker control.
- Load-holding brake for great control.
- Smooth and reliable all-metal three-stage planetary gear train.
- Limited lifetime warranty (mechanical), 3-year warranty (electrical).
- Pulling strength capability of 2,500 lb (1,134 kg).
- 50 ft. of 3/16" (15 m of 4.8 mm) wire steel cable.
- Roller fairlead.
- Wire harness (715002453) required for installation.
- Winch mounting plate is required for G2S.
- EC-compliant.

WARN VRX 35 Winch	G2, G2L, G2S	715006108	2 383 zł
-------------------	--------------	-----------	----------



- Extreme IP68-rated waterproof sealing keeps the elements out.
- Durable all-metal construction.
- Black powder-coated finish and stainless-steel fasteners for corrosion resistance.
- Robust new clutch design based on 70+ years of WARN 4WD hub lock know-how.
- Handlebar-mounted rocker control.
- Load-holding brake for great control.
- Smooth and reliable all-metal three-stage planetary gear train.
- Limited lifetime warranty (mechanical), 3-year warranty (electrical).
- Pulling strength capability of 3,500 lb (1,361 kg).
- 50 ft. of 7/32" (15 m of 5.5 mm) wire steel cable.
- Roller fairlead.
- Wire harness (715002453) required for installation.
- Winch mounting plate is required for G2S.
- EC-compliant.

WARN VRX 35-S Winch	G2, G2L, G2S	715006109	2 898 zł
---------------------	--------------	-----------	----------



- Extreme IP68-rated waterproof sealing keeps the elements out.
- Durable all-metal construction.
- Black powder-coated finish and stainless-steel fasteners for corrosion resistance.
- Robust new clutch design based on 70+ years of WARN 4WD hub lock know-how.
- Handlebar-mounted rocker control.
- Load-holding brake for great control.
- Smooth and reliable all-metal three-stage planetary gear train.
- Limited lifetime warranty (mechanical), 3-year warranty (electrical).
- Pulling strength capability of 3,500 lb (1,361 kg).
- 50 ft. of 3/16" (15 m of 4.8 mm) synthetic rope.
- Cast aluminum fairlead.
- Wire harness (715002453) required for installation.
- Winch mounting plate is required for G2S.
- EC-compliant.

WINCHES ACCESSORIES

Wireless Remote Control	WARN Winches	715002542	1 047 zł
	<ul style="list-style-type: none"> ▪ The system is quick and easy to install, thanks to a wiring harness with an integrated antenna and all necessary mounting hardware. ▪ The system allows you to operate your winch from anywhere within a 50' (15.2 m) radius, increasing your recovery options. ▪ All components are weatherproof. 		
Wired Remote Control	Can-Am WARN Winches 2020 & prior	715006378	375 zł
	Can-Am HD Winches 2021 & prior (715006414 & 715006415)	715006555	138 zł
	Can-Am HD Winches 2021 & up (715008140 & 715008141)	715008121	139 zł
	<ul style="list-style-type: none"> ▪ This kit allows winch owners to add the hand-held remote to their winch. ▪ This kit allows winch owners to add the handheld remote to vehicles with a stock winch. ▪ Works in conjunction with the mini-rocker switch. ▪ Wired Remote & Remote Socket included. ▪ EC-compliant. 		
Winch Accessories Kit	715002409	588 zł	
	<ul style="list-style-type: none"> ▪ Get the most out of your winch. ▪ Double your pulling power, change your pulling direction and keep your winch in proper working order. ▪ Includes tree straps, snatch block, shackle and winching gloves. 		
WARN Hawse Fairlead	WARN Winches	715007698	344 zł
	<ul style="list-style-type: none"> ▪ Double powder-coated construction. ▪ Required to use the Synthetic Winch. ▪ Cable (715004254) on WARN winches. ▪ To be used with synthetic winch cables only. 		
Roller Fairlead	WARN Winches	715007699	329 zł
	Can-Am HD Winch	710007459	239 zł
	<ul style="list-style-type: none"> ▪ Features top, bottom and side rollers for less cable wear and smoother operation from any direction for easier winching. 		
Hook with Safety Latch & Strap Kit	Can-Am HD Winches	705014949	95 zł
	<ul style="list-style-type: none"> ▪ Heavy-duty winch-rope hook with stainless steel snap. ▪ Includes a nylon safety strap. 		
Replacement Wire Rope – Can-Am HD	705014983	92 zł	
	705014984	176 zł	
	<ul style="list-style-type: none"> ▪ Play it safe, always carry a replacement wire rope. ▪ 2,500 lb (1,134 kg) pulling strength with 50 ft of 3/16" (15.2 m of 4.8 mm) wire rope for 705014983. ▪ 3,500 lb (1,588 kg) pulling strength with 50 ft of 7/32" (15.2 m of 5.5 mm) wire rope for 705014984. 		

Replacement Wire Rope – ATV WARN Winches

715006256

344 zł



- Play it safe, always carry a replacement wire rope.
- 3,500 lb (1,588 kg) pulling strength.
- 50 ft. of 3/32" (15.2 m of 5.5 mm) aircraft grade steel wire.

Synthetic Winch Cable

ATV WARN Winches

715004254

642 zł



- Easier to manipulate than steel cable.
- Replaces the original cable on any factory installed WARN winch or sold as an accessory by BRP.
- Kit includes synthetic rope and rock guard sleeve.
- Always use with the new Hawse Fairlead (715007698).
- 50 ft. (15.2 m) of 3/16" (15.2 m of 4.8 mm) synthetic rope.
- 3,500 lb (1,588 kg) pulling strength.

Winch Mounting Plate

G2S

715000927

595 zł



- Adds functionality to your Renegade.
- Fits Can-Am winches by WARN.

Winch Wire Harness

*(Not illustrated)*G2 2021, G2S 2021,
G2L 2020 & prior

715002453

214 zł

- Required plug-and-go wiring to install WARN winch only.
- Not required for Can-Am HD winches.

Hardware Adapter Kit

(Not illustrated)

Deluxe Fairing

715003477

206 zł

- Required to install WARN Winch Kit (715008137, 715008138, 715008139) on 2016 and up models.
- Required to install Can-Am HD 2500 Winch (715008140) and Can-Am HD 3500 Winch (715008141) on G2L 2017 and up models.

HITCHES

HITCHES

Rear Hitch

G2, G2L (except 6x6 models),
G2S



715001925

245 zł





- E-coat finish.
- Fixed hitch ball mounting bracket.
- Provides fixed mounting point for trailer ball to provide vehicle with towing capabilities.
- This hitch offers 1,300 lb (590 kg) of towing capacity.
- Hitch ball not included.

HITCHES ACCESSORIES

Rear Receiver Hitch	G2S 2012 with 800R or 1000 engines G2S 2013 & up, G2L & G2	715005186	567 zł
	<ul style="list-style-type: none"> E-coat finish. Does not affect ground clearance. Trailer ball not included. On 4X4 use, this hitch offers 1,500 lb (680 kg) of towing capacity. On 6x6 use, this hitch offers 1,654 lb (750 kg) of towing capacity. Compliant with European T regulations. Not compatible with G2L models with Rear Skid Plates. 		
Front Receiver Hitch	G2	71500921	474 zł
	<ul style="list-style-type: none"> Front receiver hitch for Outlander with or without a winch. This hitch offers 1,300 lb (590 kg) of towing capacity. Allows you to maneuver your trailer easily in tight, confined areas. Hitch bar sold separately. Not compatible with Extreme Front Bumper, Rancher Bumper and ProMount Plows. 		
Rubber Receiver Plug		705204503	58 zł
	<ul style="list-style-type: none"> Rubber cap for 2" (5 cm) hitch receiver. 		

PERFORMANCE

PERFORMANCE

Renegade Snorkel Kit	G2S (2020 & prior)	715006000	2 931 zł
	G2S (2021 & up)	715007083	2 908 zł
	<ul style="list-style-type: none"> Comprehensive kit. Extended air intakes and CVT exhaust. CVT outlet integrates into pod cover. Ideal for muddy conditions. 		
Renegade Radiator Relocator Kit	G2S	715001929	2 243 zł
	<ul style="list-style-type: none"> Relocates radiator to top mount position. Prevents cooling performance loss in muddy conditions. Uses existing radiator. Includes support, hardware and hoses. Engineered for easy cooling system bleeding and maintenance. Radiator not included. Renegade Extreme Front Bumper (715002469) required for installation (except X mr). 		
Mud Strap	G2, G2L, G2S	715003053	214 zł
	<ul style="list-style-type: none"> Convenient sturdy grab-handle. Lets drivers redistribute their weight for improved traction in demanding conditions. Not compatible with XT Handlebar Protector Kit (703100352). 		

Radiator Protector	G2, G2S (except G2S with 500 engine)	715001744	321 zł
	<ul style="list-style-type: none"> ▪ Metal shield that mounts over radiator face, providing protection from stones and branches. 		
Outlander Snorkel Kit	G2 2015 & up, G2L (except X mr & 6x6 models)	715005999	2 087 zł
	G2 (2012-2014 only)	715001730	1 954 zł
<ul style="list-style-type: none"> ▪ Comprehensive kit. ▪ Extended air intakes and CVT exhaust. ▪ CVT outlet integrates into pod cover. ▪ Must be installed on a vehicle without XT Handlebar Protector Kit. ▪ Ideal for muddy conditions. ▪ Not compatible with windshields. 			
Outlander Snorkel Kit	G2 (X mr models only), G2L (X mr models only)	715002518	509 zł
	<ul style="list-style-type: none"> ▪ Comprehensive kit. ▪ Extended air intakes and CVT exhaust. ▪ CVT outlet integrates into pod cover. ▪ Must be installed on a vehicle without XT Handlebar Protector Kit. ▪ Ideal for muddy conditions. ▪ Not compatible with windshields. ▪ Raised horn only. ▪ Provides higher intake. ▪ For best fit and finish, appropriate gauge support is required. 		
Outlander Radiator Relocator Kit	G2, G2L (except 6x6 models)	715001930	2 243 zł
	<ul style="list-style-type: none"> ▪ Relocates radiator to top mount position. ▪ Prevents cooling performance loss in muddy conditions. ▪ Uses existing radiator. ▪ Includes support, hardware and hoses. ▪ Engineered for easy cooling system bleeding and maintenance. ▪ Radiator not included. 		
X mr Traction Plates	G2 (MAX models only), G2L	715001752	544 zł
	<ul style="list-style-type: none"> ▪ Provide extra foot grip for driver when riding in extreme mud conditions. ▪ Help driver maintain ideal riding position to maximize vehicle traction. ▪ Made of aluminum. ▪ Not meant for a passenger. 		
Self-Clearing Footwells	G2 2015 & up, G2L	715004759	1 341 zł
	<ul style="list-style-type: none"> ▪ Made from aluminum. ▪ Replace original footwells. ▪ Feature large evacuation ports to avoid mud and snow accumulation in footwells. ▪ Aggressive design for improved traction. ▪ Not compatible with Body Side Protectors. ▪ Sold in pairs. 		
Footpeg Kit	G2, G2L	715001131	245 zł
	<ul style="list-style-type: none"> ▪ Provides maximum integrated grip and more stability during vigorous riding. ▪ Kick-up end generates added grip during hard cornering. ▪ Made of aluminum. ▪ Sold in pairs. 		

Foam Air Filter by Twinair[†]

G2, G2S, G2L

715001333

340 zł



- Maximizes performance by increasing air flow throughout RPM range.
- Maintenance-friendly, i.e., just wash, re-oil and re-use after riding in severely dusty/muddy environments.

Heavy-Duty Springs

G2 2012-2018 (Base model, DPS, XT, X mr with 650 engine only & Limited - except 6x6) G2S (Base model with 500 & 570 engines only)
G2L (Except Mossy Oak, PRO, 6x6 and X mr models)
G2 2012-2018 (Base model, DPS, XT & X mr with 650 engine only - except 6x6) G2S (Base model with 500 & 570 engines only)
G2 2019 (Base, DPS & XT models - except 6x6)

715003199 • Front

578 zł

715007203 • Front

578 zł

715003200 • Rear

578 zł

715005159 • Front & Rear

1 162 zł



- Heavy-duty springs provide enhanced stiffness.
- Perfect for snow clearing and hauling heavy loads.
- Improves handling and helps prevent accidental overturns.
- Sold in pairs.
- Standard on Outlander Pro and Mossy Oak models.

Front Shock Covers

G2, G2L, G2S

715500301

210 zł



- Feature ventilation holes.
- Offer added protection in rough terrain and weather conditions.
- Sold in pairs.

YOSHIMURA

Yoshimura Slip-On Exhaust – Outlander

G2 (except 6x6 models)

715005480

- zł



- Made from 304-grade stainless steel.
- Better sounding, better looking and lighter than stock muffler.
- USDF/USDA approved spark arrester.
- NON EPA compliant (for racing application only).
- Not EC compliant.
- Fuel injection system tuning not required.
- Not compatible with CARB & T Category models 2018 and up.

Yoshimura Slip-On Exhaust – Renegade

G2S 2012 & up (except 570 engine and X mr models)

715005481

- zł



- Made from 304-grade stainless steel.
- Better sounding, better looking and lighter than stock muffler.
- USDF/USDA approved spark arrester.
- NON EPA compliant (for racing application only).
- Not EC compliant.
- Fuel injection system tuning not required.
- Not compatible with CARB & T Category models 2018 and up.

EMERGENCY ACCESSORIES

Emergency Kit

715006102 • US only

665 zł

715006103 • CA only

705 zł



- Complete emergency kit provides all essential equipment and supplies to get out of most unfavorable situations powersport enthusiasts may find themselves in.
- Includes jumper cables, air compressor, tire-repair kit, first-aid kit, ratchet tie-down, duct tape, 3,300 lb (1,500 kg) tow strap, zip-ties and cloth rags.

COVERS, DECALS & ADD-ONS

Trailer Covers	G2 (except MAX models)	715001737	989 zł
	G2 (MAX and X mr 1000R models only)	715001736	1 191 zł
	G2L (except MAX models)	715002026	989 zł
	G2L (MAX models only)	715002025	1 214 zł
	G2S (except X mr models)	715000683	891 zł



- Heavy-duty canvas made of UV-resistant solution-dyed polyester.
- Protect windshield and colored panels from abrasion.
- All high-abrasion areas are reinforced with a double canvas layer.
- Opening for fuel cap access.
- Weather-resistant trailable cover protects your vehicle during transportation.
- Quick and easy installation.
- Designed to perfectly fit your vehicle with or without Can-Am accessories.

Storage Covers	G2, G2L, G2 X mr (except 1000), G2L X mr, G2S, G2S X mr	715001720	1 006 zł
	G2, G2L (MAX and Xmr 1000R models only)	715001668	960 zł
	G2 (6x6 models only)	715002492	1 394 zł
	G2, G2L (except MAX models)	715001597 • Mossy Oak Break-Up Country Camo	1 139 zł
	G2 MAX, G2 X mr 1000, G2L MAX	715001735 • Mossy Oak Break-Up Country Camo	1 191 zł



- Weather-resistant storage covers.
- For vehicle storage only.
- UV-resistant solution-dyed polyester construction.
- Quick and easy installation.
- Designed to perfectly fit your vehicle with or without Can-Am accessories.

Flag	715000277 • Yellow	134 zł
-------------	---------------------------	---------------



- Make sure everyone knows what you're riding.
- Perfect for the dunes and new riders.
- 8-ft. (2.4 m) length.
- Includes flag mount (715000127).

Flag Mount (Not illustrated)	715000127	98 zł
--	------------------	--------------

Bolt-On⁺ Retractable Ratcheting Tie-Downs	295100737	165 zł
---	------------------	---------------



- Perfect for transporting your powersport vehicle or securing loads.
- Mounts easily: Bolts on any flat surface (e.g., truck bed or frame).
- 1" x 6' (2.5 cm x 1.8 m) tie-down strap with heavy-duty stitching that delivers a 500 lb (226 kg) working load strength and 1,500 lb (680 kg) break strength.
- Convenient retractable push button automatically slackens, spools and stores away strap, while the ratchet mechanism tightens the strap snugly to secure your vehicle or load into place.
- Rubber ratcheting handle provides firm grip, and the hook is vinyl coated to protect whatever surface it hooks into.
- Sold in pairs.

Ratchet Tie-Downs	715008309 • Black/Grey	92 zł
--------------------------	-------------------------------	--------------



- 400 lb (181 kg) safe working load.
- 1" x 10' (2.5 cm x 3 m) strap with Can-Am, Sea-Doo, and Ski-Doo logos.
- Deluxe ratchet with rubber handle.
- Coated S hooks.
- Pack of 2.

Heavy-Duty Ratchet Tie-Down		715008308	203 zł
------------------------------------	--	------------------	---------------



- 1,000 lb (454 kg) safe working load.
- 1.5" x 6' (38 mm x 1.8 m) strap with BRP brands.
- Deluxe ratchet with rubber handle.
- Black-coated clip hooks.
- 12" (300 mm) webbing included.
- Pack of two.

Shifter Lock	G2, G2L	715007337	256 zł
---------------------	---------	------------------	---------------



- Secure the vehicle's shifter by locking it in position.
- Prevents the vehicle from going into neutral without the lock key.

Lockable Gas Tank Cap	G2, G2L, G2S	860200387	206 zł
------------------------------	--------------	------------------	---------------



- Protects your fuel.
- Meets EPA requirements.

License Plate Bracket	G2L	715002498	100 zł
	G2S	715001401	107 zł



- Provides specific area to install license plate.
- Mounts to rear of vehicle.

Decal		704901483	69 zł
--------------	--	------------------	--------------



- 6" x 12 3/4" (15 cm x 32 cm).

APACHE TRACK SYSTEMS

APACHE TRACK SYSTEMS

Apache Backcountry Track System

G2 (except 6x6 models), G2S, G2L

715003042

27 956 zł



- Designed to deliver the best flotation level and deep-snow performance on the market.
- Contact patch is 23% bigger than the Apache 360 LT.
- Impressive added ground clearance of 7" (18 cm), keeps the vehicle out of deep snow.
- Aggressive track design with 2" (5 cm) lug height for maximum traction on snow.
- Apache Backcountry Mounting Kit and engine and CVT air intake pre-filters are required.
- For winter use only.

Idler Wheel Kit

Apache Backcountry Track System (rear tracks only)

860201230 • 141 mm

249 zł



- Reduces drag and rolling resistance.
- Includes 2 wheels, brackets and hardware.
- Add up to 2 kits per rear track.
- Can extend slider life in hardened snow conditions.

Sliders with Vespel[®] Inserts

Apache Backcountry Track System

503194815

428 zł



- Use DuPont Vespel inserts for less friction.
- Longer life.
- Can be cut to desired length.
- 8 needed per vehicle.
- Sold individually.

Rail Ice Scratchers

Apache Backcountry Track System

860201728

- zł



- Provide additional lubrication in hard and icy conditions.
- Rail mounted, small, light.
- Design expands on coil concept to allow reversing without damage.
- Easily stored when not in use.

APACHE 360 & 360 LT

Apache 360 Track System

G2 (except 6x6 models), G2L, G2S

715006323

21 405 zł



- Multifunctional tracks perfect for any Can-Am ATV.
- Average ground clearance of 16" (41 cm).
- 1" (2.5 cm) lugs in the front and 1.25" (3.2 cm) in the back.
- Apache 360 & 360 LT Mounting Kit and engine and CVT air intake pre-filters are required.

Apache 360 LT Track System

G2, G2L, G2S

715005103

27 373 zł



- Multifunctional tracks designed to support heavy loads and to fit on most Can-Am Off-Road vehicles.
- Front wheel height adjustment provides enhanced attack angle and better performance over rough terrain when raised or increased contact patch for improved flotation when lowered.
- Average ground clearance increase of 4.5" (11.4 cm).
- 1" (2.5 cm) lugs in the front and 1.25" (3.2 cm) in the back.
- Reliable heavy-duty build.
- EC compliant.
- Contact patch is 7 to 9% bigger than the Apache 360's.
- Apache 360 and 360 LT Mounting Kit, Track DPS.
- Module and engine and CVT air intake pre-filters are required.

APACHE 360 LT 6X6

Apache 360 LT (6x6) Track System	G2, G2L (6x6 only)	715005104	33 169 zł
---	--------------------	------------------	------------------



- Multifunctional tracks designed to support heavy loads and to fit on most Can-Am Off-Road vehicles.
- Front wheel height adjustment provides enhanced attack angle and better performance over rough terrain when raised or increased contact patch for improved flotation when lowered.
- Average ground clearance increase of 4.5" (11.4 cm).
- 1" (2.5 cm) lugs in the front and 1.25" (3.2 cm) in the back.
- Apache 360 LT Mounting Kit, Track DPS Module and Engine & CVT Pre-Filter Kit are required.
- Reliable heavy-duty build.
- EC compliant.
- Exclusively for the Outlander 6x6.
- Recommended for use on snow only.

ATV TRACK SYSTEM FITTING GUIDE

TRACK KIT	VEHICLE	MOUNTING KIT	DPS MODULE (2021 & up)	Pre-Filter
Apache Backcountry 715003042	G2, G2S 2018 & prior & G2L	715004830	715007338	Air Intake Pre-Filter 715004729 + CVT Air Intake Pre-Filter 715003483 <i>Standard on G2 models and G2L PRO model</i>
	G2, G2S 2019 & up	715004796		
Apache 360 715006323	G2, G2S 2018 & prior & G2L	715007207		
	G2, G2S 2019 & up	715007206		
Apache 360 LT 715005103	G2, G2S 2018 & prior & G2L	715007207		
	G2, G2S 2019 & up	715007206		
Apache 360 LT 6x6 715005104	G2 2018 & prior, G2L (6x6 models)	715004991		
	G2 6x6 models 2019 & up	715005105		

APACHE ACCESSORIES

Apache Backcountry Mounting Kit <i>(Not illustrated)</i>	G2 2018 & prior, G2S 2018 & prior, G2L	715004830	2 872 zł
	G2 2019, G2S 2019	715004796	

- Required for installation of the Apache Backcountry Track System.
- DPS module and pre-filter are required and sold separately.

Track DPS Module <i>(Not illustrated)</i>	G2, G2L, G2S (models without Intelligent Throttle Control (ITC))	715005243	583 zł
	G2, G2L, G2S (models with Intelligent Throttle Control (ITC))	715007338	463 zł

- An innovative DPS module that ensures speedometer accuracy and optimized steering assist, which make for perfect track control and riding ease.
- Required to install the Apache and Backcountry Track Systems.

Apache 360 & 360 LT Mounting Kit <i>(Not illustrated)</i>	G2 2018 & prior (except 6x6 models) G2S 2018 & prior, G2L	715007207	1 670 zł
	G2 2019 & up (except 6x6 models), G2S 2019 & up	715007206	1 670 zł
	G2 2018 & prior, G2L (6x6 models)	715004991	984 zł
	G2 (6x6 models 2019 & up)	715005105	984 zł

- Required to install Apache 360 & 360 LT Track Systems.
- DPS module and pre-filter not included.

Engine Air Intake Pre-Filter	G2, G2L, G2S	715004729	172 zł
-------------------------------------	--------------	------------------	---------------



- Adds extra protection to your engine in harsh riding conditions.
- Filter blocks particles larger than 0.005" (0.13 mm).
- Necessary to maintain vehicle warranty when tracks are installed.

APACHE TRACK SYSTEM ACCESSORIES

Cvt Air Intake Pre-Filter

715003483

209 zł



- Adds extra protection to your engine in harsh riding conditions.
- Filter blocks particles larger than 0.007" (0.19 mm).
- Easy, tool-less installation.
- Necessary to maintain vehicle warranty when tracks are installed.
- Required to install the Apache and Backcountry Track Systems.
- Standard on Outlander 650, 650 X mr, 850, 1000, 1000R engines and G2L PRO.
- Not compatible with Snorkel kits

Self-Clearing Footwells

G2 2015 & up, G2L

715004759

1 341 zł



- Made from aluminum.
- Replace original footwells.
- Feature large evacuation ports to avoid mud and snow accumulation in footwells.
- Aggressive design for improved traction.
- Not compatible with Body Side Protectors.
- Sold in pairs.

ProMount PLOWS

STEEL PLOWS

Can-Am ProMount Steel Plow Kits – 54" (137 cm) Blade

G2, G2L, G2S

■ **715007753** • Black
■ **715008178** • Yellow

- zł



- These kits include:
 - Can-Am ProMount Steel Blade.
 - Push Frame with Quick-Attach System.
 - Mounting Plate.

Can-Am ProMount Steel Plow Kits – 60" (152 cm) Blade

G2, G2L, G2S

■ **715007754** • Black
■ **715008179** • Yellow

- zł



- These kits include:
 - Can-Am ProMount Steel Blade.
 - Push Frame with Quick-Attach System.
 - Mounting Plate.

Can-Am ProMount Steel Plow Kits – 66" (168 cm) Blade

G2, G2L, G2S

■ **715007755** • Black
■ **715008180** • Yellow

- zł



- These kits include:
 - Can-Am ProMount Steel Blade.
 - Push Frame with Quick-Attach System.
 - Mounting Plate.

Can-Am ProMount Steel Blades – 54" (137 cm) Blade

Fits ProMount Push Frame

■ **715004472** • Black
■ **715005316** • Yellow

1 316 zł

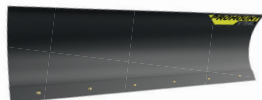

- Blades available individually to create your own kit.
- Compatible with Can-Am ProMount Blade accessories to further enhance plow versatility (some plow accessories are not compatible with 54" (137 cm) plows).
- Not compatible with ProMount Drift Cutters, Blade Extensions and Edge Markers.
- Clears 50" (127 cm) when plow is fully angled.
- Blade height of 14.75" (37 cm).

Can-Am ProMount Steel Blades – 60" (152 cm) Blade

Fits ProMount Push Frame

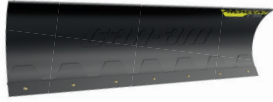
 ■ 715004202 • Black
 ■ 715005317 • Yellow
1 436 zł

- Blades available individually to create your own kit.
- Compatible with Can-Am ProMount Blade accessories to further enhance plow versatility.
- Clears 54" (137 cm) when plow is fully angled.
- Blade height of 17" (43 cm).

Can-Am ProMount Steel Blades – 66" (168 cm) Blade

Fits ProMount Push Frame

 ■ 715006337 • Black
 ■ 715006338 • Yellow
1 645 zł

- Blades available individually to create your own kit.
- Compatible with Can-Am ProMount Blade accessories to further enhance plow versatility.
- Clears 60" (152 cm) when plow is fully angled.
- Blade height of 17" (43 cm).

Can-Am ProMount Steel Blades – 72" (183 cm) Blade

Fits ProMount Push Frame

 ■ 715004474 • Black
 ■ 715006021 • Yellow
1 951 zł

- Blades available individually to create your own kit.
- Compatible with Can-Am ProMount Blade accessories to further enhance plow versatility.
- Clears 66" (168 cm) when plow is fully angled.
- Blade height of 17" (43 cm).

ANGLE PLOWS**Can-Am ProMount Angle Blades – 60" (152 cm) Steel Oneway State Blade**

G2, G2L, G2S

715007261**1 707 zł**

- Make the job easier with the right tools, clear long alleys and make the task easier by sending the snow further out of the way.
- Wing end of plow measures 25" (63 cm) high and tapers down to 17" (43 cm).
- One-way "winged" state plow designed to throw snow higher.
- Rubber flap designed to keep snow away from the driver.
- Can-Am branded.

Can-Am ProMount Angle Blades – 66" (168 cm) Steel Oneway State Blade

G2, G2L, G2S

715007263**1 993 zł**

- Make the job easier with the right tools, clear long alleys and make the task easier by sending the snow further out of the way.
- Wing end of plow measures 25" (63 cm) high and tapers down to 17" (43 cm).
- One-way "winged" state plow designed to throw snow higher.
- Rubber flap designed to keep snow away from the driver.
- Can-Am branded.

Can-Am ProMount Angle Blades – 72" (183 cm) Steel Oneway State Blade

G2, G2L, G2S

715007264**2 191 zł**

- Make the job easier with the right tools, clear long alleys and make the task easier by sending the snow further out of the way.
- Wing end of plow measures 25" (63 cm) high and tapers down to 17" (43 cm).
- One-way "winged" state plow designed to throw snow higher.
- Rubber flap designed to keep snow away from the driver.
- Can-Am branded.

ProMount One-Way State Blade Rubber Flap*(Not illustrated)***715007299****500 zł**

- Allows for more efficient snow projections in various snow conditions.

CAN-AM ProMount FLEX2 PLOWS

Can-Am ProMount Flex2 Plows – 60" (152 cm) Kit	G2, G2L, G2S	715008181	- zł
---	--------------	------------------	-------------



- These kits include:
 - Can-Am ProMount Flex2 Blade.
 - Push Frame with Quick-Attach System.
 - Mounting Plate.

Can-Am ProMount Flex2 Blades – 60" (152 cm) Blade	Fits ProMount Push Frame	715004203	1 801 zł
--	--------------------------	------------------	-----------------



- Plow blade made of UHMWPE, flexible and impact absorbing material prevents damaging your plow when accidental impacts occur.
- Replacable wear blade.
- Large pin designed for easy blade rotation to eliminate snow buildup at pivot point.
- Blade design provides best snow roll-off at any angle.
- Compatible with Can-Am ProMount Blade accessories to further enhance plow versatility.
- Clears 54" (137 cm) when plow is fully angled.

Can-Am ProMount Flex2 Blades – 72" (183 cm) Blade	Fits ProMount Push Frame	715004485	2 394 zł
--	--------------------------	------------------	-----------------



- Plow blade made of UHMWPE, flexible and impact absorbing material prevents damaging your plow when accidental impacts occur.
- Replacable wear blade.
- Large pin designed for easy blade rotation to eliminate snow buildup at pivot point.
- Blade design provides best snow roll-off at any angle.
- Compatible with Can-Am ProMount Blade accessories to further enhance plow versatility.
- Clears 66" (168 cm) when plow is fully angled.

CAN-AM ProMount PLOW ACCESSORIES

Can-Am ProMount Push Frame with Quick-Attach System	G2, G2L, G2S	715007752	2 024 zł
--	--------------	------------------	-----------------



- Heavy-duty steel tubes designed to withstand the roughest use.
- Mid-mount carriage provides ultimate push strength and traction.
- Designed for maximum plow lift height.
- Features a self-aligning quick-attach system, an easy foot release pedal and an ergonomic handle for plow angle adjustment.
- Plow Roller Fairlead and Plow Limit Switch recommended to extend winch cable lifespan.
- Can-Am ProMount Mounting Plate required for installation.
- Blade swivels left or right, 5 positions.
- Large pin designed for easy blade rotation to eliminate dirt and snow buildup at pivot point.

Can-Am ProMount Mounting Plate	G2, G2L, G2S	715007751	599 zł
---------------------------------------	--------------	------------------	---------------



- Required to install the Can-Am ProMount Push Frame with Quick-Attach System.
- Mounting plate precision-designed to stay on year round without compromising ground clearance.
- Fits on ATVs with or without Can-Am Skid Plates.
- Plow Roller Fairlead included.

Can-Am ProMount Push Frame Extension	G2, G2L, G2S	715006257	708 zł
---	--------------	------------------	---------------



- 12" (30 cm) push frame extension.
- Required when plow is installed with Apache Track System.

Can-Am ProMount Edge Markers	G2, G2L, G2S	715004206	190 zł
-------------------------------------	--------------	------------------	---------------



- Help locate the edges of your plow.
- Height: 24" (60 cm).
- Sold in pairs.
- Compatible with Can-Am ProMount Steel and Flex2 Blades with or without Blade Extensions (except for the Can-Am ProMount Steel 54" (137 cm) Blades).

Can-Am ProMount Drift Cutters

G2, G2L, G2S

715004207

645 zł



- Help keep snow in the plow.
- Dimensions: 17" x 13" (43.2 cm x 33 cm).
- Sold in pairs.
- Compatible with Can-Am ProMount Steel and Flex2 Blades with or without Blade Extensions (except for the Can-Am ProMount Steel 54" (137 cm) Blades).

Can-Am ProMount Curved Wear Blade

G2, G2L, G2S

715007791 • 60" (152 cm)

715007792 • 66" (168 cm)

469 zł



- Wear blade designed with a folded back bottom lip.
- The increased surface allows for less digging while plowing uneven surfaces.
- Ideal for snow covered gravel, grass, paver stone and other soft surfaces.

Can-Am ProMount Plastic Wear Blade

G2, G2L, G2S

715004480 • 54" (137 cm)

715004481 • 60" (152 cm)

715004482 • 66" (168 cm)

715004483 • 72" (183 cm)

385 zł

385 zł

385 zł

645 zł



- To help prevent scratches on smooth driveways and markable surfaces.

Can-Am ProMount Blade Extensions

G2, G2L, G2S

■ 715004205 • Black

■ 715005319 • Yellow

474 zł



- Add 3" (8 cm) each side.
- Compatible with Can-Am ProMount Blades (except for Can-Am ProMount Steel 54" (137 cm) Blade).
- Longer Wear Blade can be installed to further extend the extra length already provided by the extensions.
- Compatible with Can-Am ProMount Steel and Flex2 Blades (except for the Can-Am ProMount Steel 54" (137 cm) Blades).

Back Drag Blade

ProMount Plows (60" and more)

715007794

1 119 zł



- ¼ thick steel swivel scraper.
- Lifts up when the vehicle is moving forward so as not to affect the scraping.
- Increased capacity to pull snow.
- More aggressive scraping in reverse mode.
- Lifts the blade off the ground so that it scrapes evenly.
- Adjustable in length for compatibility with 60", 66" and 72" blades.
- Compatible with ProMount blades (Flex and Steel).

Plow Roller Fairlead

G2, G2L, G2S

705009222

286 zł



- Larger diameter lower roller reduces wear on wire rope for plow application.
- Can be used with all ProMount plows.

Pulley Kit for Alpine Super-Duty Plow

G2, G2L, G2S

715000279

236 zł



- Pulley kit to be used in conjunction with the winch when using a snow plow.
- Recommended to increase winch efficiency.
- To be used with the XT Front Bumper.

Synthetic Winch Cable for Plowing

715000540

206 zł



- Specially designed for plowing applications.
- 8' (2.4 m) section of durable, extra-strong synthetic rope.
- Stands up to repeated, sharp angle pulls used to lift heavy plow blades.
- Temporarily replace your winch rope for plow season to save wear and tear on wire rope.

Plow Limit Switch

(Not illustrated)

G2, G2L, G2S

715004775

547 zł

- For controlling the cable tension when over raising your plow system.
- Prevents winch, plow push frame and vehicle damage.

Can-Am ProMount Plow Angling System

G2, G2L, G2S

715007801

3 257 zł

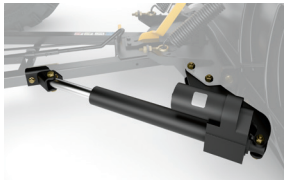

- Converts your plow system into an easy-to-control unit from the driver's seat.
- Using one hand to control all plow motions will allow you to easily concentrate and manage your plowing tasks.
- Compatible with ProMount Blade.
- Push Frame 715007752 is required.
- Push Frame Extension 715006257 is required for installation with the Front Rancher Bumper.
- Winch and plow sold separately.

TIRES & RIMS

TIRES

Carlisle ACT Tire	G2 (500-1000 XT models only)	705401333 • Front 705401334 • (C€)	566 zł
		705501769 • Rear 705501770 • (C€)	587 zł



- Front - 26" x 8" x 12".
- Rear - 26" x 10" x 12".

Carlisle ACT Tire	G2 (400 XT models only)	705400606 • Front 705400326 • (C€)	521 zł
		705500933 • Rear 705500598 • (C€)	541 zł



- Front - 25" x 8" x 12".
- Rear - 25" x 11" x 12".

Carlisle ACT HD Tire		705402562 • Front	566 zł
		705502940 • Rear	587 zł



- Front - 26" x 8" x 12".
- Rear - 26" x 10" x 12".

Carlisle Badlands A/R Tire	G2 (500-1000 Base models only)	705401331 • Front 705401332 • (C€)	566 zł
		705501767 • Rear 705501768 • (C€)	606 zł



- Front - 26" x 8" x 12".
- Rear - 26" x 10" x 12".

Carlisle Trail Wolf Tire	G2 (400 Base models only) G2L (450/570)	705402433 • Front 705400607 • (C€)	566 zł
		705502856 • Rear 705502165 • (C€)	541 zł



- Front - 25" x 8" x 12".
- Rear - 25" x 11" x 12".

ITP TerraCross Tire	G2 XTP, G2 Limited	705402435 • Front	606 zł
		705502858 • Rear	692 zł



- This smooth-riding tire will command every bit of traction from the ground while still managing to float across loose snow, sand and mud.
- Features extreme-duty construction for improved puncture protection and extra-tough rubber compound for increased tread life. The interlocking tread pattern and wide footprint make it one of the toughest and grippiest radials around.
- Not EC compliant.
- Front - 26" x 8" x 14".
- Rear - 26" x 10" x 14".

ITP Holeshoot ATR Tire	G2S	705400600 • Front 705400475 • (€)	606 zł
		705500926 • Rear 705500820 • (€)	521 zł
 <ul style="list-style-type: none"> • Front - 205/80R12 - 25" x 8" x 12". • Rear - 270/60R12 - 25" x 10" x 12". 			
ITP Mega Mayhem	G2 X mr 570 & 650 2018 & up G2S X mr 570 2018 & up	705402131 • Front	847 zł
		705502645 • Rear	867 zł
 <ul style="list-style-type: none"> • 1.5" tread depth mud thrower tires. • Surprisingly smooth ride on hard pack surfaces. • 6-ply rated. • Front - 28" x 9" x 12". • Rear - 28" x 11" x 12". 			
ITP Cryptid Tire	G2 X mr 850 & 1000R 2018 & up G2S X mr 1000R 2018 & up	705402671	827 zł
 <ul style="list-style-type: none"> • Graduated lug height and paddle-like shoulder configuration provide maximum side bite for climbing in and out of the mud without compromising ride comfort on trails and hard pack. • 6-ply rated. • 30" x 9" x 14". 			
Gorilla Silverback Tire	G2 (850 & 1000 models only)	705400962	1 042 zł
 <ul style="list-style-type: none"> • AT30X9-14 Gorilla Silverback mud tire. • Sold individually. • Not EC compliant. • 30" x 9" x 14". 			
Maxxis Mudzilla Tire	G2 (X mr 570 & 650 models only)	705401391 • Front	651 zł
		705501836 • Rear	737 zł
 <ul style="list-style-type: none"> • Not EC compliant. • Front - 28" x 8" x 12". • Rear - 28" x 10" x 12". 			
Kenda Klaw MXR Tire	DS 90 X	V42711DGF01HLL • Front	411 zł
		V42712DGF01HLL • Rear	351 zł
 <ul style="list-style-type: none"> • Front - 20" x 6" x 10". • Rear - 18" x 10.5" x 8". 			

RIMS

14" Rim	G2 DPS, G2 XT, G2 MAX 650, G2 MAX XT, G2 MAX Limited	705401853 • Front 705401852 • Front 705401851 • Front 705502402 • Rear 705502401 • Rear 705502400 • Rear	<ul style="list-style-type: none"> ■ Black and machined ■ Black with clear coat ■ Silver with clear coat ■ Black and machined ■ Black with clear coat ■ Silver with clear coat 	<ul style="list-style-type: none"> 677 zł 630 zł 630 zł 735 zł 677 zł 677 zł
 <ul style="list-style-type: none"> • Premium cast aluminum black painted with machining and clear coat rim. • Center hole: 72 mm. • Bolt circle pattern: 4/136 mm. • Front - 14" x 6.5" offset = 40 mm. • Rear - 14" x 8.5" offset = 50 mm. <p><i>Note: Matching Nuts - 250100100 Black, 250100082 Chrome/ Matching Cap - 705400928</i></p>				

14" Rim	G2 DPS, G2 XT, G2 MAX Limited, G2 North Edition, G2 MAX North Edition	705402309 • Front	■ Black and machined	630 zł
		705402222 • Front	■ Black with clear coat	630 zł
		705402307 • Front	■ Silver with clear coat	630 zł
		705502770 • Rear	■ Black and machined	735 zł
		705502702 • Rear	■ Black with clear coat	677 zł
		705502768 • Rear	■ Silver with clear coat	677 zł



- Front - 14" x 6.5" offset = 40 mm.
- Rear - 14" x 8.5" offset = 50 mm.

Outlander X mr and Defender Rim	X MR models front and rear wheels	705401848 • Front	■ Black and machined	735 zł
		705401849 • Front	■ Black	



- Cast aluminum rim with trend setting explosive styling so you can ride—and look—like a trailblazer.
- Front - 14" x 6.5" offset = 10 mm.

Note: Matching Nuts - 250100100 Black, 250100082 Chrome/Matching Cap - 705401541

Outlander Rim (Camo Model)	G2, G2L, G2S	705401127 • Front	■ Black with clear coat	752 zł
		705501493 • Rear	■ Black with clear coat	798 zł



- Black with clear coat aluminum rim.
- Front - 12" x 6" offset = 41 mm.
- Rear - 12" x 7.5" offset = 51 mm.

12" Beadlock Rim	G2, G2L, G2S	705401678 • Front	■ Black	1 087 zł
		705502244 • Rear	■ Black	1 110 zł



- Black with clear coat aluminum rim.
- Needs 16 bolts (250000787) for installing the beadlock.
- Choice of beadlock color (not included).
- Front - 12" x 6" offset = 41 mm.
- Rear - 12" x 7.5" offset = 51 mm.

12" Beadlock Ring	G2, G2L, G2S	705401763 • ■ Can-Am Red	705401811 • ■ Orange Crust	370 zł
		705401810 • ■ Yellow	705401812 • ■ Manta Green	364 zł



- Cast aluminum beadlock.
- Must be installed on Front Rim (705401678) and Rear Rim (705502244).

Note: Matching Nuts - 250100184 Black, 250100185 Chrome/Matching Cap - 705400928

14" Beadlock Rim	G2	705401594 • Front	■ Black	1 295 zł
		705502146 • Rear	■ Black	



- Black with clear coat aluminum rim.
- Choice of beadlock color (not included).
- Needs 16 bolts (250000787) for installing the beadlock.
- Front - 14" x 6.5" offset = 41 mm.
- Rear - 14" x 8" offset = 51 mm.

14" Beadlock Ring	G2	705401586 • ■ Manta Green	705401811 • ■ Can-Am Red	428 zł
		705401702 • ■ Octane Blue	705401812 • ■ Black	



- Cast aluminum beadlock.
- Must be installed on Front Rim (705401594) and Rear Rim (705502146).

Note: Matching Nuts - 250100184 Black, 250100185 Chrome/Matching Cap - 705400928

EXPLORE AN ENTIRE WORLD OF ADVENTURE WITH ALL OF OUR BRP PRODUCTS. BRP.COM



ski-doo LYNX SEA-DOO can-am ROTAX ALUMACraft Manitou QUINTREX





CAN-AMOFFROAD.COM

